

Rosettes - Face fixed

A selection of seven traditional period designs of face fixed Rosettes, four of which are available in two sizes; and all seven are designed to work in conjunction with the Door Levers & Door Knobs to be found in sections ST1 & ST2.

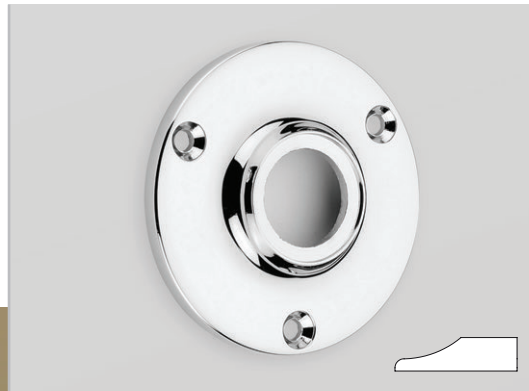

▲ 2721

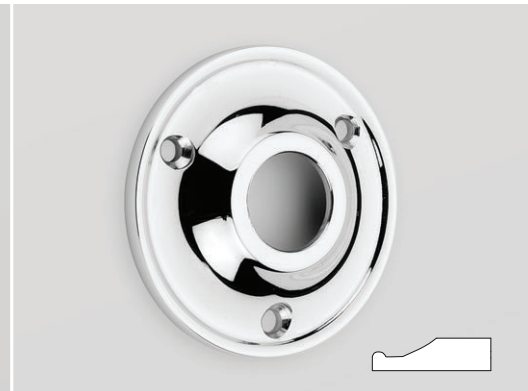

▲ 2722

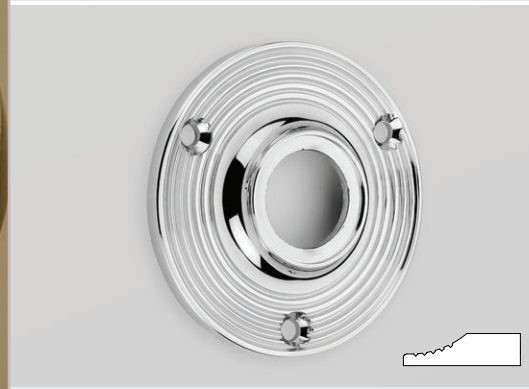

▲ 2727

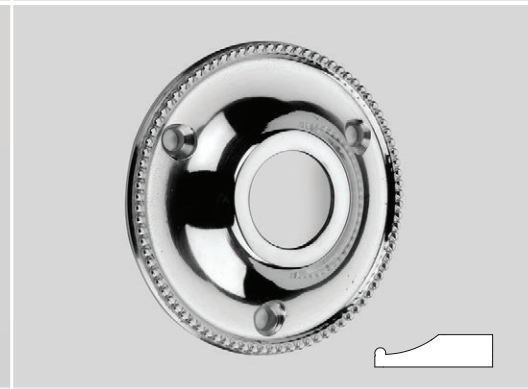

▲ 2738



▲ 2755 57 x 57 x 7



▲ 2731 63 x 43 x 6



▲ 2753 70 x 45 x 10

Fixings

Supplied with finish matched no.6 x 19mm wood screws, alignment collars and installation instructions.

How to Order

Split Finish Sets - order as singles

- 1) select ROSETTE/BACKPLATE (e.g. 2755)
- 2) add FINISH (e.g. 2755PB)
- 3) 2721, 2722, 2727 & 2738 only - add SIZE (e.g. 2722PB/B).

For HALF SET (single rosette) add/H (e.g. 2755PB/H or 2722PB/B/H).

Finishes - See our price list or website for finish availability.

	A	B	Proj
2721/2727	Ø 57	Ø 63	10
2722/2738	Ø 57	Ø 65	12



FIX DEAD DUMMY MOUNT achieved using 9001 (sold separately see page ST16:080).



ALIGNMENT COLLARS SUPPLIED

Rosettes - Concealed fix

A selection of six traditional period designs of concealed fix Rosettes, all available in four sizes; and all designed to work in conjunction with the Door Levers & Door Knobs to be found in sections ST1 & ST2.



Fixings

Supplied with subroses, no.4 x 13mm wood screws, alignment collars and installation instructions.

Fix Dead Rosettes are supplied with 7813 mounts in place of standard subroses (*).

Pair of Pre-Bore Rosettes (sizes C & D only) supplied with 7800 Pre-Bore Adaptor in place of standard subroses (*).

(* See pages ST6:070 & 080 for details.

How to Order

Split Finish Sets - order as singles

- 1) select ROSETTE (e.g. **7834**)
- 2) add FINISH (e.g. **7834PB**)
- 3) add SIZE (**7834PB/B**).

For HALF SET (single rosette) add/H (e.g. **7834PB/B/H**).

For pair of rosettes FIX DEAD add FDS (e.g. **7834PB/B/FDS**).

For single rosette FIX DEAD add FD (e.g. **7834PB/B/H/FD**).

For PRE-BORE ADAPTOR (sizes C & D only) add PRE (e.g. **7834PB/C/PRE**).

Finishes - See our price list or website for finish availability.

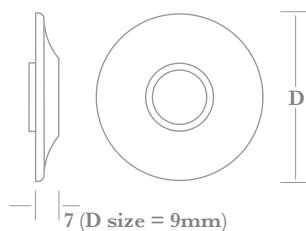
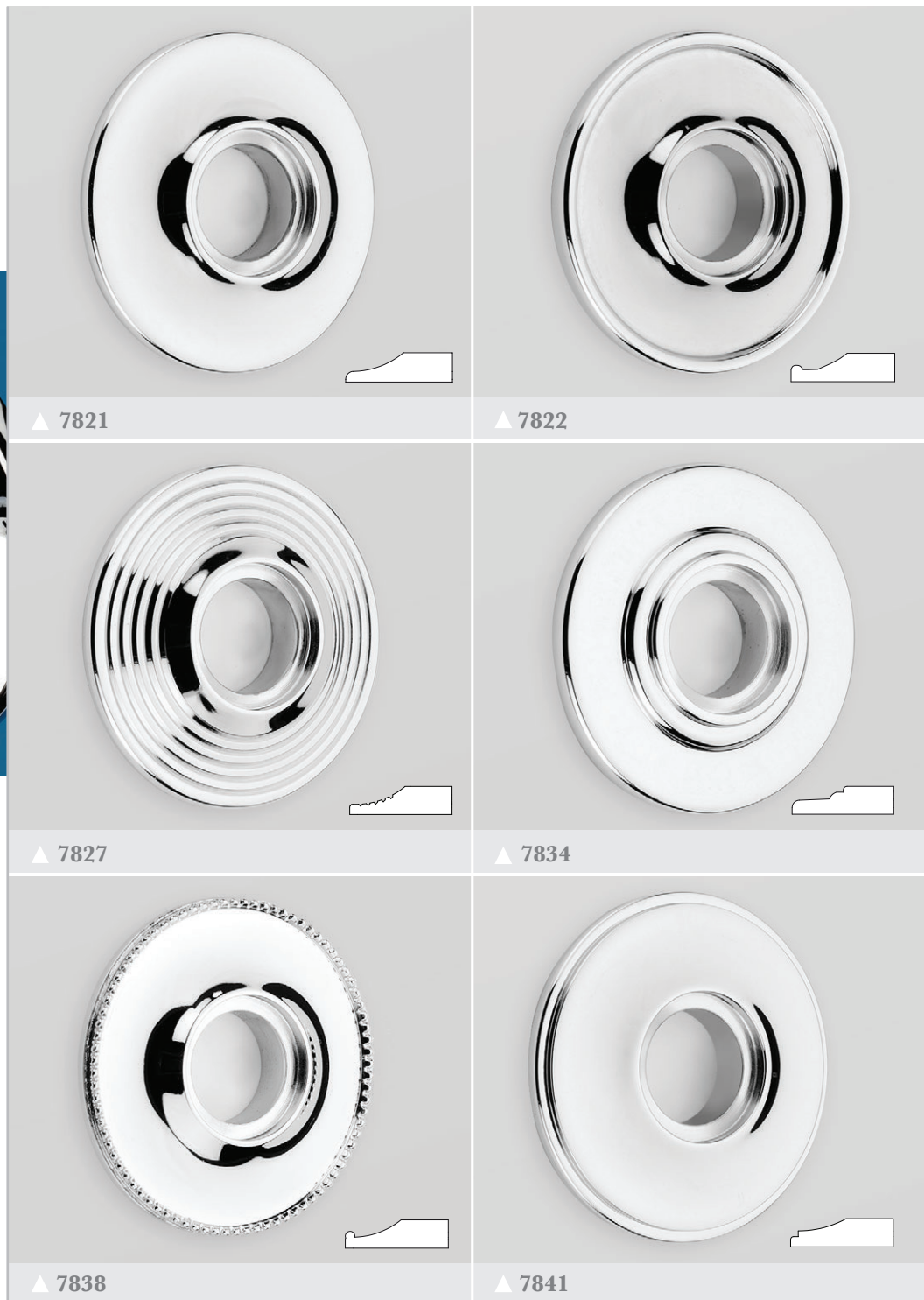

	A	B	C	D
D (dia)	Ø 44	Ø 54	Ø 64	Ø 76

Custom sizes available upon request - surcharge may apply.

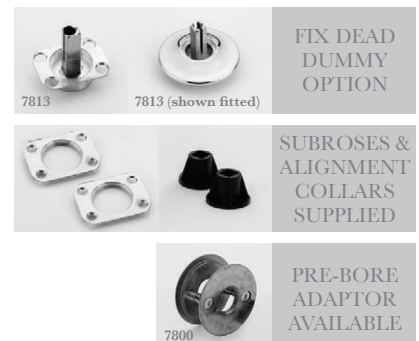

Rosettes - Concealed fix

Four modern contemporary, and two traditional period, designs of concealed fix Rosettes. All are available in up to four sizes, and all are designed to work in conjunction with the Door Levers & Door Knobs to be found in sections ST1 & ST2.

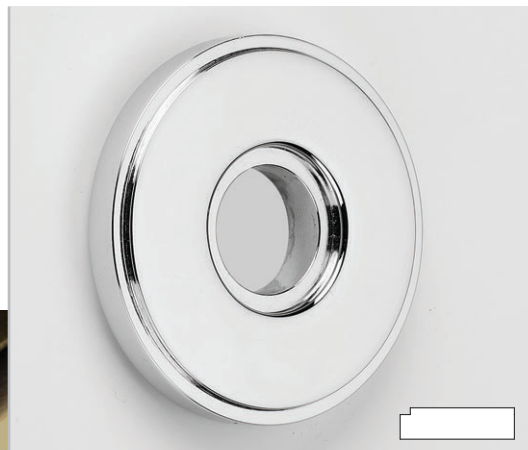

▲ 7842

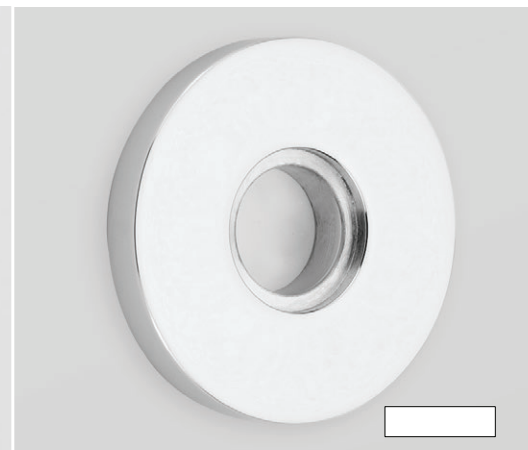

▲ 7843

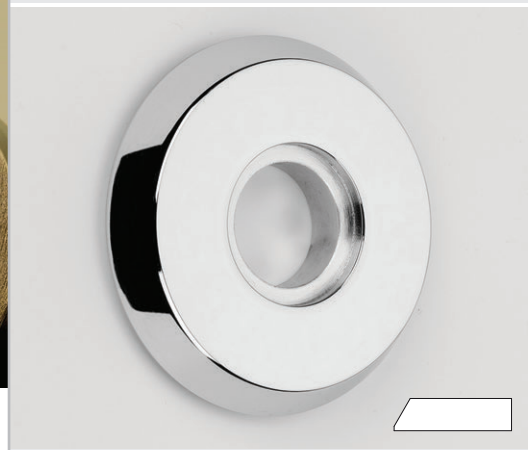

▲ 7844

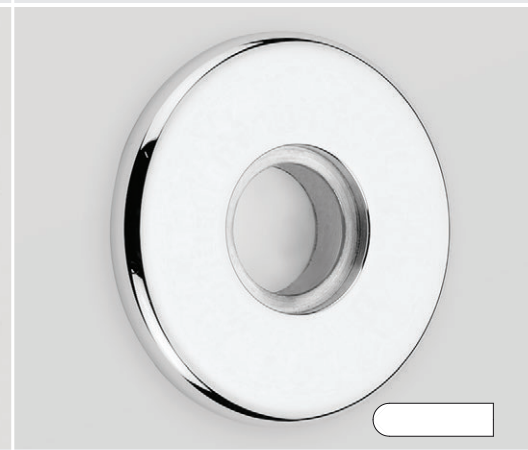

▲ 7845 (available in B, C & D size only)

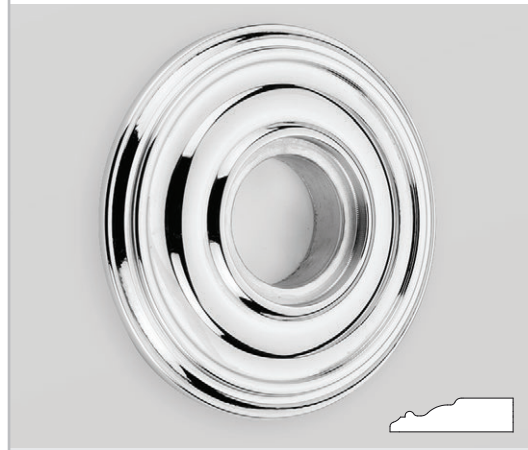

▲ 7846

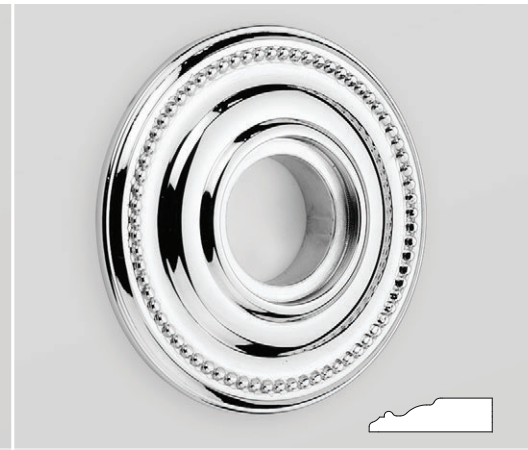

▲ 7847

Fixings

Supplied with subroses, no.4 x 13mm wood screws, alignment collars and installation instructions.

Fix Dead Rosettes are supplied with 7813 mounts in place of standard subroses (*).

Pair of Pre-Bore Rosettes (sizes C & D only) supplied with 7800 Pre-Bore Adaptor in place of standard subroses (*).

(* See pages ST6:070 & 080 for details.

How to Order

Split Finish Sets - order as singles

1) select ROSETTE (e.g. **7846**)

2) add FINISH (e.g. 7846**PB**)

3) add SIZE (7846**PB/B**).

For HALF SET (single rosette) add/H (e.g. 7846PB/B/**H**).

For pair of rosettes FIX DEAD add FDS (e.g. 7846PB/B/**FDS**).

For single rosette FIX DEAD add FD (e.g.7846PB/B/H/**FD**).

For PRE-BORE ADAPTOR (sizes C & D only) add PRE (e.g. 7846PB/C/**PRE**).

Finishes - See our price list or website for finish availability.

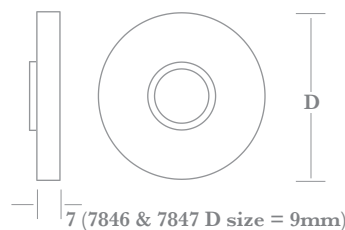

	A	B	C	D
D (dia)	Ø 44	Ø 54	Ø 64	Ø 76

Custom sizes available upon request - surcharge may apply.

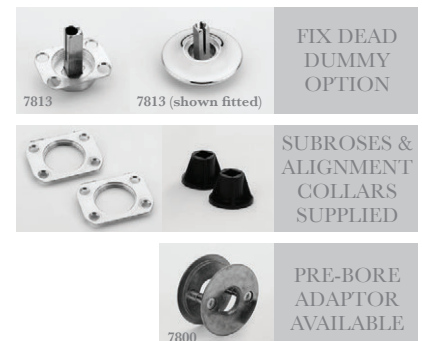

FIX DEAD DUMMY OPTION

SUBROSES & ALIGNMENT COLLARS SUPPLIED

PRE-BORE ADAPTOR AVAILABLE

Rosettes - Concealed fix

Two octagonal design concealed fix Rosettes - both designed to work in conjunction with the Door Levers & Door Knobs to be found in sections ST1 & ST2.

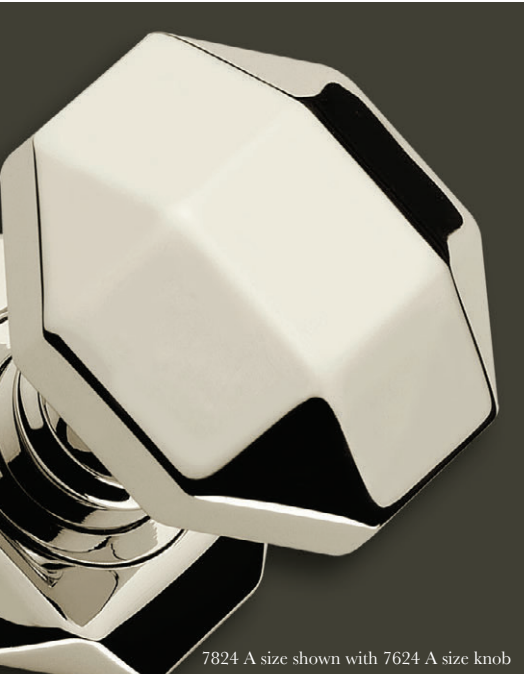

7824 A size shown with 7624 A size knob

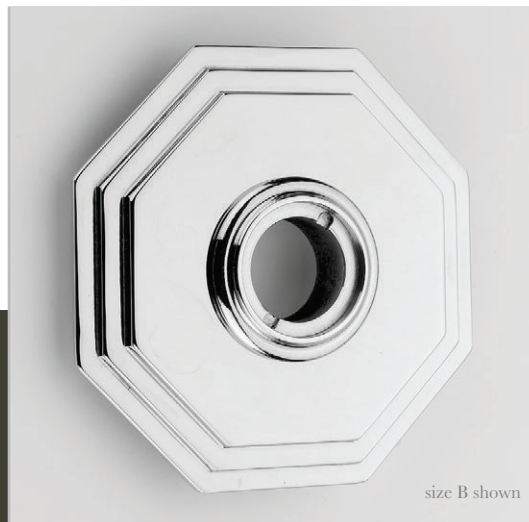

size B shown

▲ 7825

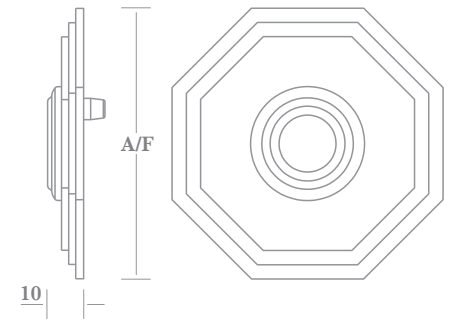

	A	B
Size A/F	64	76

Custom sizes available upon request - surcharge may apply.



size A shown

▲ 7824

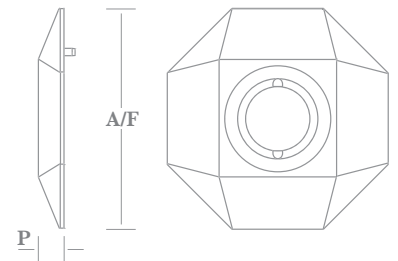

	A	B	C
Size A/F	53	60	70
P (projection)	6	7	8

Custom sizes available upon request - surcharge may apply.

Fixings

Supplied with subroses, no.4 x 13mm wood screws, alignment collars and installation instructions.

Fitted with anti-rotation pegs.

Fix Dead Rosettes are supplied with 7813 mounts in place of standard subroses (*).

Pair of Pre-Bore Rosettes supplied with 7800 Pre-Bore Adaptor in place of standard subroses (*).

(* See pages ST6:070 & 080 for details.

How to Order

Split Finish Sets - order as singles

- 1) select PLATE (e.g. **7825**)
- 2) add FINISH (e.g. 7825**PB**)
- 3) add SIZE (7825**PB/B**).

For HALF SET (single rosette) add/H (e.g. 7825**PB/B/H**).

For pair of rosettes FIX DEAD add FDS (e.g. 7825**PB/B/FDS**).

For single rosette FIX DEAD add FD (e.g.7825**PB/B/H/FD**).

For PRE-BORE ADAPTOR (*) add PRE (e.g. 7825**PB/B/PRE**).

(* Cannot be used with 7824A or B

Finishes - See our price list or website for finish availability.



SUBROSES & ALIGNMENT COLLARS SUPPLIED

7800

PRE-BORE ADAPTOR AVAILABLE

7813

FIX DEAD DUMMY OPTION