

HEWI

INSPIRATION

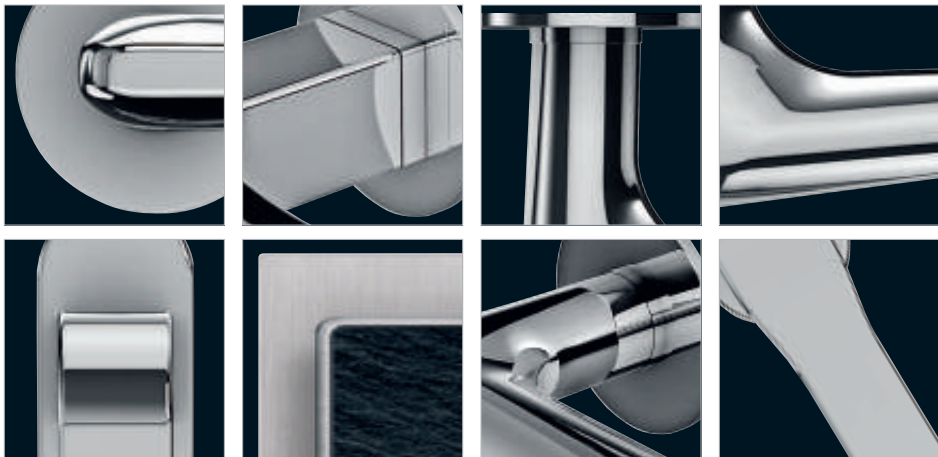

AC LEIGH

ARCHITECTURAL IRONMONGERS
SECURITY SPECIALISTS

CONTENT

Made in Germany	4
Range 860	6
Range 250	8
Range 260	10
Flat Rose	12
Range 180	16
System 100	20
Range 120	24
System 111	26
HEWI active+	30
Safety at the Door	32
System 162	34
Handrails	36

MADE IN GERMANY SINCE 1929

SUSTAINABILITY

Resource-saving processes, top quality and extreme durability contribute to the development of eco-friendly products.



Quality management



Environmental management



Energy management

TESTED TECHNOLOGY

HEWI products are monitored by independent test institutes and therefore guarantee the highest functionality, technology and safety requirements.



Materialprüfungsamt
Nordrhein-Westfalen



Prüfinstitut Velbert



Holzforschung
Austria



Fire safety
monitoring label



RAL quality symbol
for protective fittings

SAFETY

HEWI emergency exit fittings are certified and labelled accordingly.



EN 179: Emergency exits



EN 1125: Escape routes

DESIGN EXPERTISE

HEWI has been awarded numerous renowned design prizes for the quality of its design.



PARTNER

HEWI is actively involved and is committed to an international network and is a member of the following associations.





NEW: RANGE 860

DESIGN: CLAUDIA DE BRUYN, TWO PRODUCT, RATINGEN

- Projects suitability to EN 1906 and EN 179
- Stainless steel, satin finish or mirror polished
- High-quality, glossy PVD surfaces available
- Combinable with sanitary System 800
- Lever handle and window handle available in 2015





NEW: RANGE 250

DESIGN: GIANCARLO RADDI, FLORENCE

- Projects suitability to EN 1906
- Mirror-polished stainless steel
- High-quality, glossy PVD surfaces available
- Lever handle and window handle available in 2015



Standard door fitting



Window handle



Model 251



Model 251

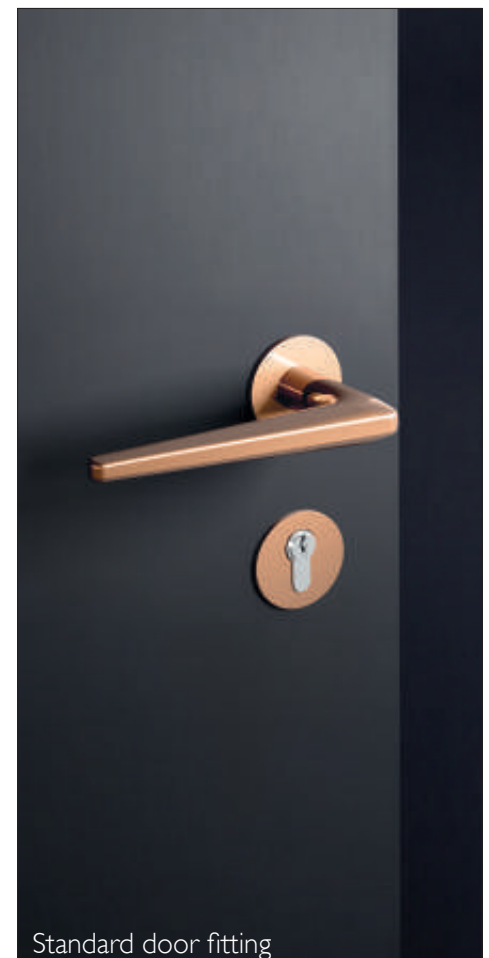

Standard door fitting



NEW: RANGE 260

DESIGN: HEWI, BAD AROLSEN

- Projects suitability to EN 1906
- Mirror-polished stainless steel
- High-quality, glossy PVD surfaces available
- Lever handle and window handle available in 2015



NEW: CLASS 4 | FLAT ROSE WITH LATCHING CONNECTION



TECHNOLOGY

- Fast and easy installation
- Toolless
- No additional machining of the door leaf necessary
- New: User category Class 4 to EN 1906
- New: Fire door fittings to DIN 18273





PUSH IT!

- Fast latching together of pre-installed assemblies
- Secured with a setscrew



FLAT ROSE

DESIGN

- Optionally available as a round or square rose
- Made of satin finish stainless steel
- Overall height 3 mm
- Diverse uses (user class 4 to EN 1906)
- Combinable with HEWI stainless steel lever door handles
- New: Fire door fittings to DIN 18273

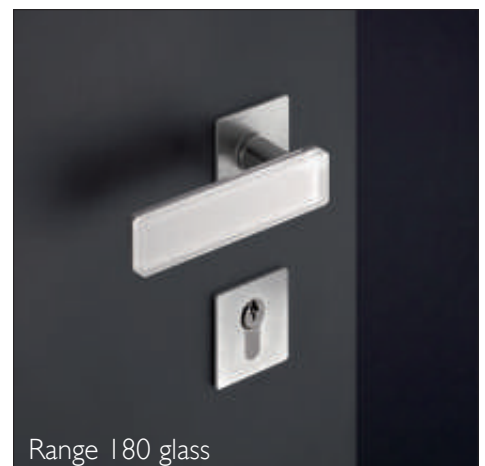
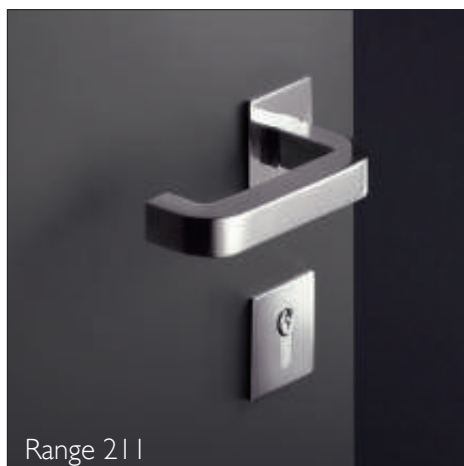
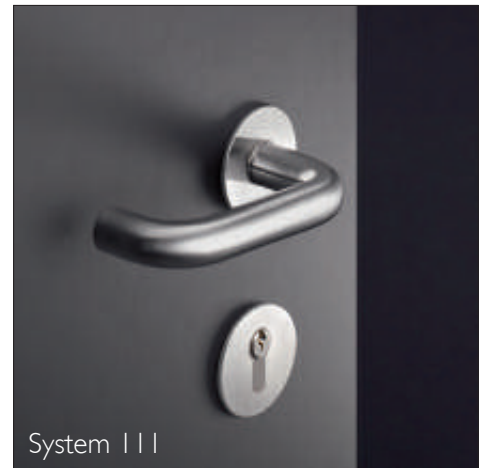
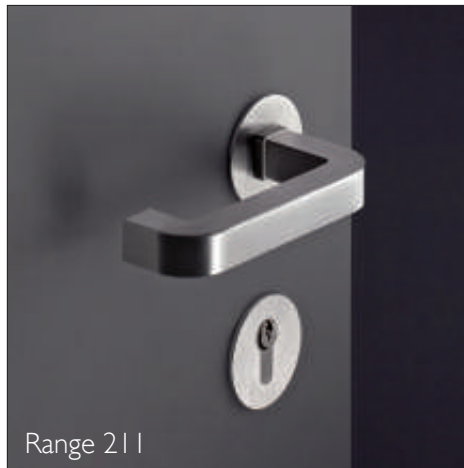
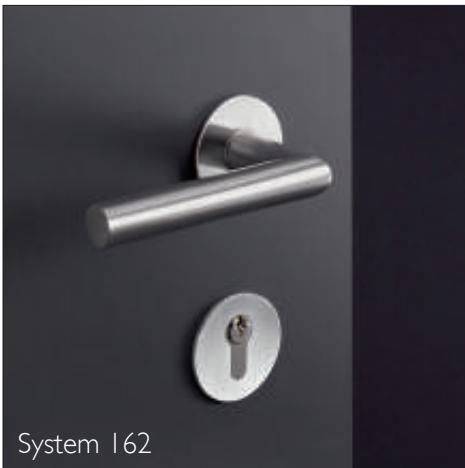



RANGE 180

NEW: PULL HANDLE

- Door fittings made of back-painted glass on a stainless steel holder
- Toughened safety glass
- Available in black, umber and white.
- Matches the GIRA "Esprit" switch range
- New: Pull handle available from July 2014

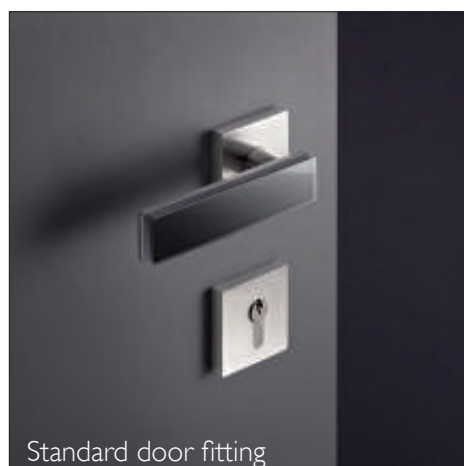
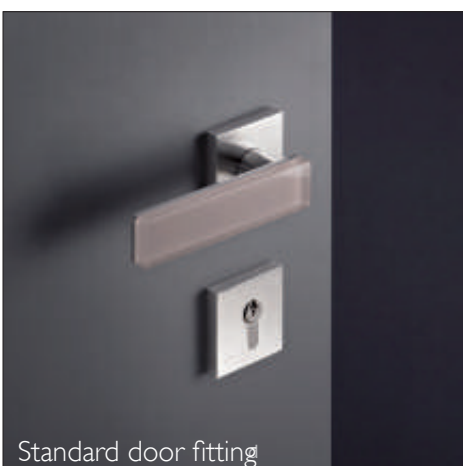

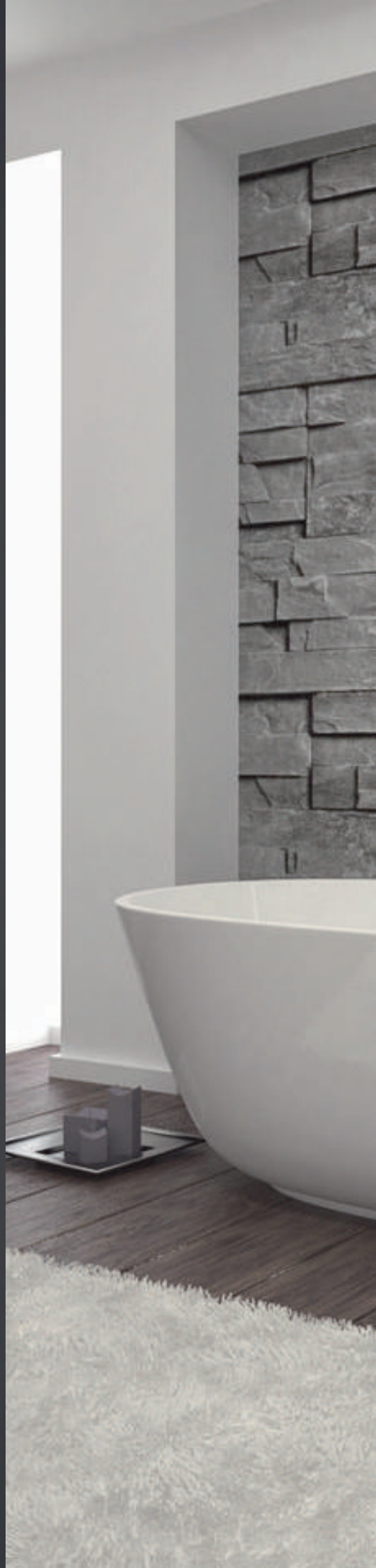

RANGE 180

SLATE, GLASS AND STAINLESS STEEL

- Received the red dot award: product design 2001
- Stainless steel lever handle with inlay made of natural slate
- Stainless steel lever handle with white glass inlay
- Complete projects range made of solid stainless steel to EN 1906, EN 179 and DIN 18273





SYSTEM 100 CI

DESIGN: PHOENIX DESIGN, STUTTGART/SUZHOU

- Prize Winner at Iconic Awards 2013
- Multi-system concept
- Selected products available with CI surface
- Champagne-coloured, high-gloss PVD coating

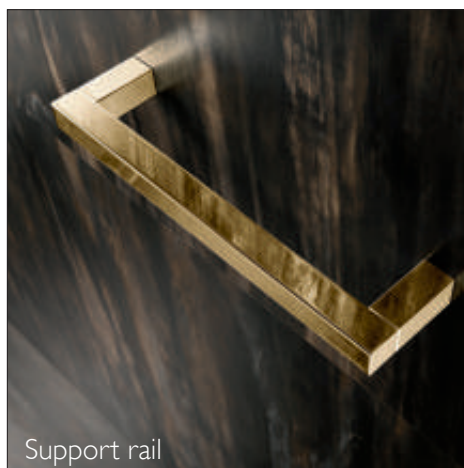



SYSTEM 100 STAINLESS STEEL

DESIGN: PHOENIX DESIGN, STUTT GART/SUZHOU

- Prize Winner at Iconic Awards 2013
- Multi-system concept
- Lever handle optionally made of stainless steel, satin finish or mirror polished
- Sanitary accessories optionally high-quality chrome-plated or white powder coated finish
- Complete projects range made of solid stainless steel to EN 1906, EN 179 and DIN 18273

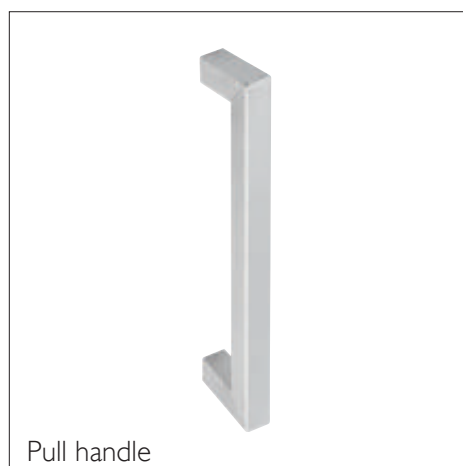
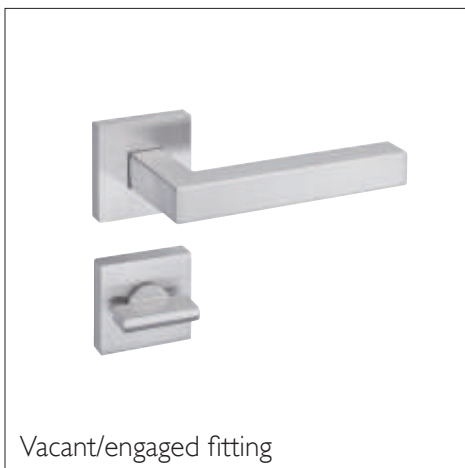

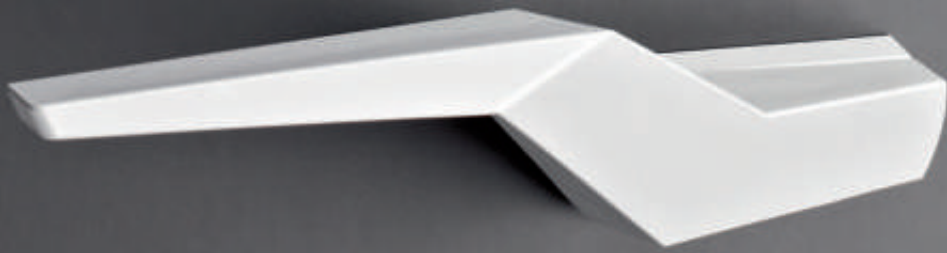

RANGE I20

DESIGN: DELUGAN MEISSL ASSOCIATED ARCHITECTS, VIENNA

- Received the red dot award: product design 2008
- Available in high-gloss white or mat black
- Two design variants
- Complete projects range to EN 1906, EN 179 and DIN 18273





SYSTEM III | MODERN CLASSIC

45 YEARS IN PROJECTS

- Received the iF product design award 1982
- Original with steel core and high-gloss polyamide surface since 1969
- Material variants: Soft Touch (Thermoplastic polyurethane) and stainless steel
- U-shaped design icons
- Selected HEWI colours
- Complete projects range to EN 1906, EN 179 and DIN 18273

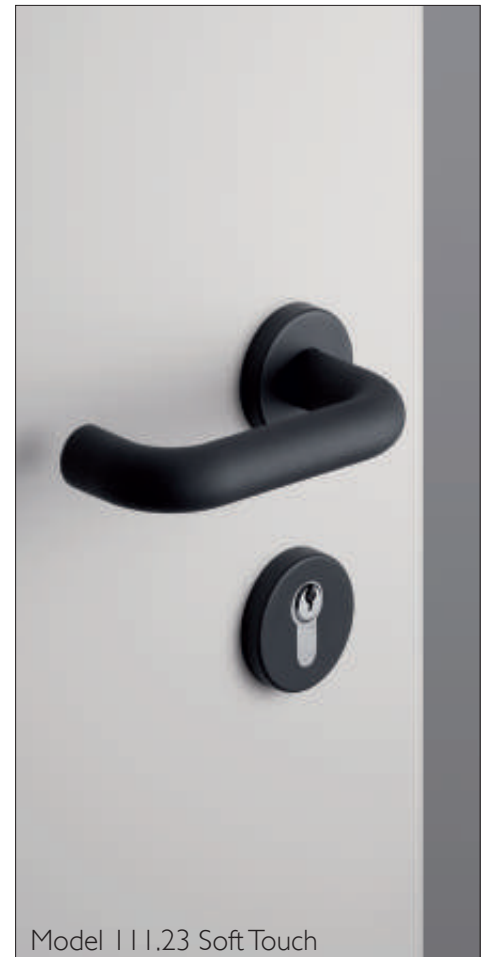
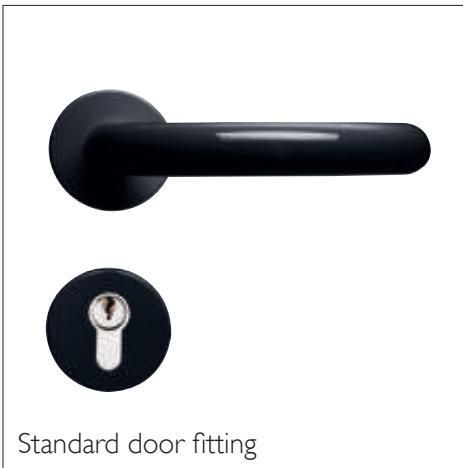



SYSTEM III

NEU: UMBER

- Design classic in umber available from October 2014
- Selected HEWI colours set accents
- Enables highly contrasting design at the door
- Handrails, cloakrooms and sanitary accessories available in matching colours



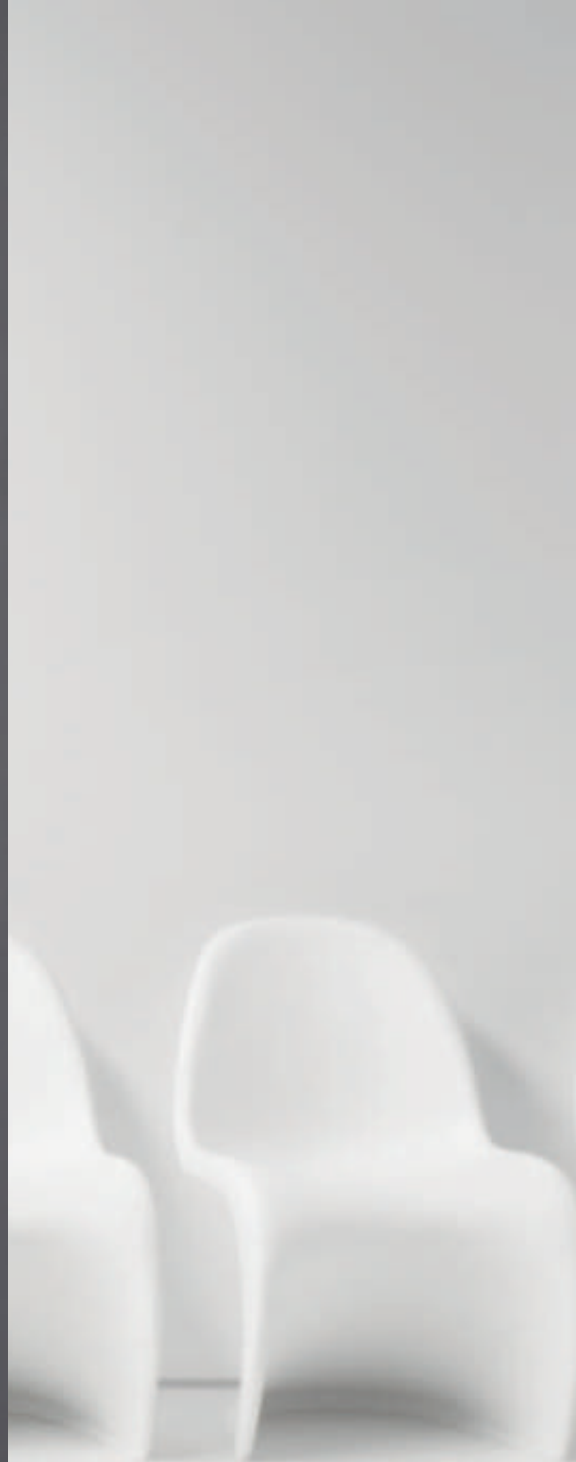

NEW: ANTIMICROBIAL PRODUCTS

- Active antimicrobial effect based on microsilver
- Broad efficacy against bacteria and fungi
- Suitable for areas with the highest hygiene requirements
- Product range labelled with logo
- Hardware and sanitary products are available in signal white

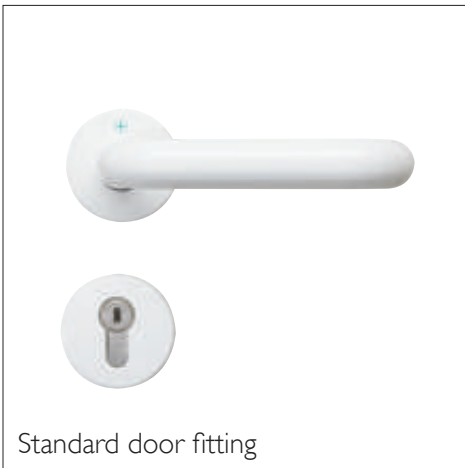

Standard door fitting



Handrail



Toilet brush unit & toilet roll holder



Pull handle



Push/pull handle



SAFETY AT THE DOOR

PANIC BAR AND PUSH/PULL HANDLE

- Nominated for the universal design award: consumer favorite 2014
- Hardware for escape routes to EN 179 and EN 1125
- Intuitive usability due to coloured or doubled-up gripping area
- New: Panic bar certified with lock manufacturer BKS, available in 2015
- Other certified lock manufacturers: Assa Abloy, BMH, Fuhr, GEZE, Grundmann, KFV, MSL, DOM and Wilka

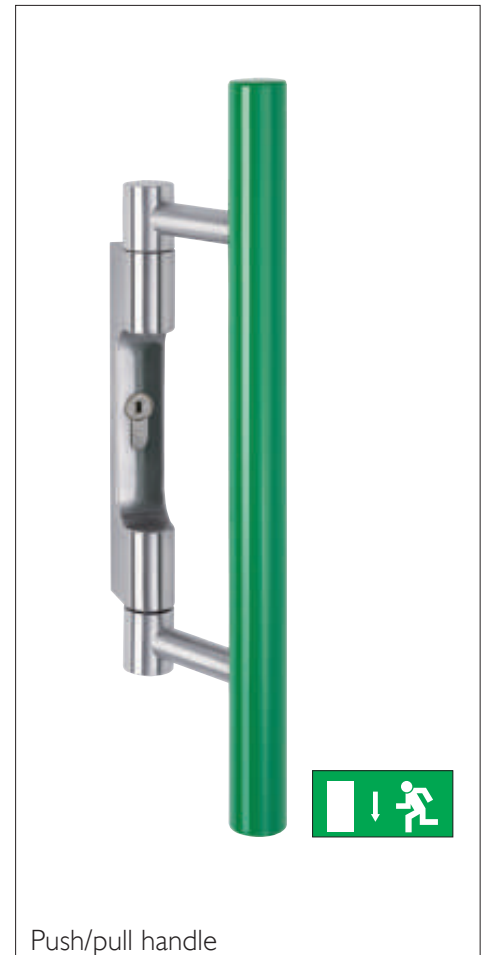

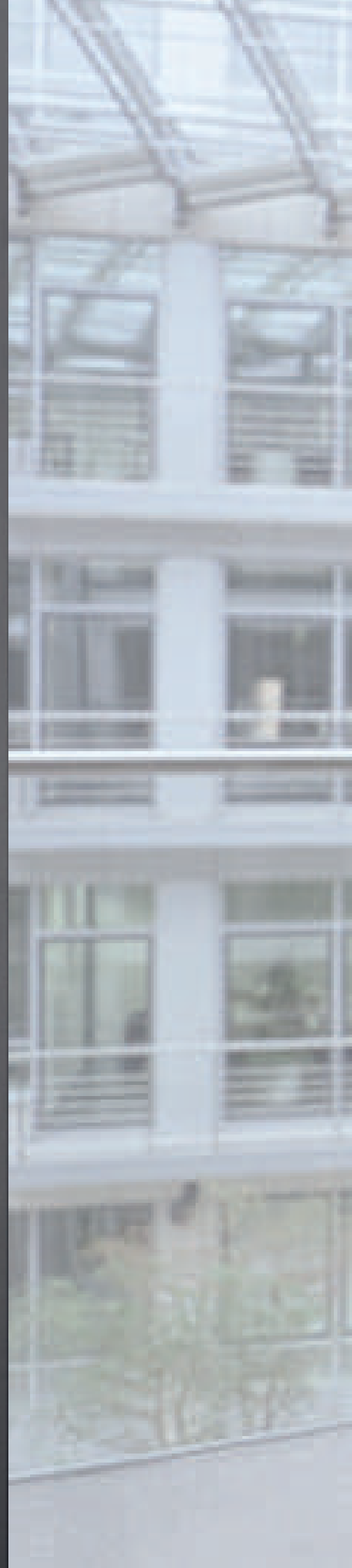

SYSTEM 162

DESIGN: NOA, AACHEN

- Lever handle and window handle optionally made of stainless steel or polyamide (pure white, anthracite grey or jet black)
- Sanitary accessories optionally made of satin finish stainless steel or high-quality chrome-plated

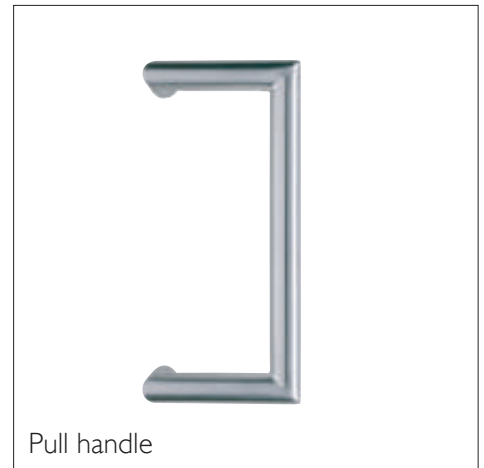
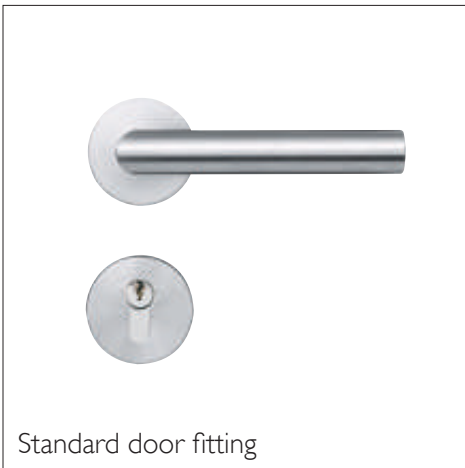



HANDRAILS

DIVERSITY

- Custom-made handrails
- Diverse component combination options
- Large choice of materials (wood, polyamide and stainless steel)

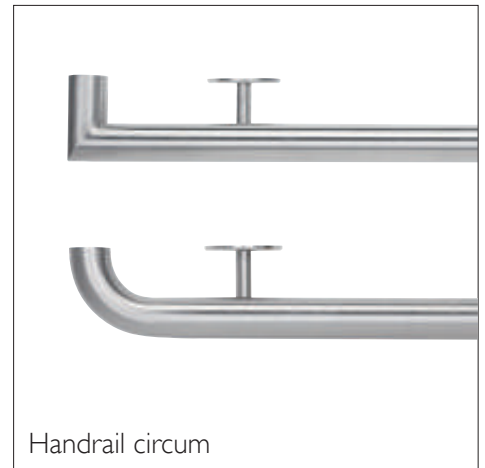
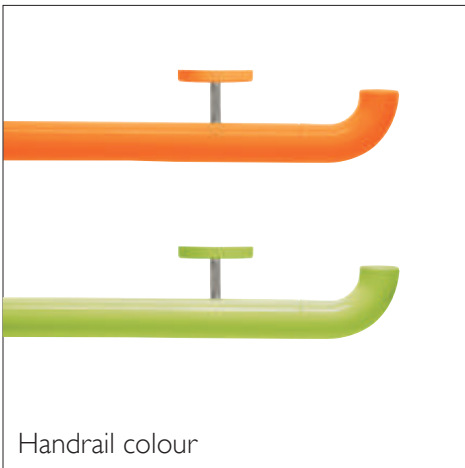

NORWICH

61-67 St. Benedicts Street,
Norwich, NR2 4PD
Tel: 01603 216500
Fax: 01603 216510
Email: sales@acleigh.co.uk

COLCHESTER

11 Grange Way,
Whitehall Industrial Estate,
Colchester, CO2 8HG
Tel: 01206 877488
Fax: 01206 877480
Email: colchester@acleigh.co.uk

IPSWICH

Unit 2-3, Dencora Business Centre,
Whitehouse Road, Ipswich, IPI 5LT
Tel: 01473 292810
Fax: 01473 292818
Email: ipswich@acleigh.co.uk

www.acleigh.co.uk