

# HEWI

## ACCESSIBILITY

INNOVATIVE SYSTEM SOLUTIONS



**AC LEIGH**

ARCHITECTURAL IRONMONGERS  
SECURITY SPECIALISTS

- 03 **Philosophy**  
Accessible Solutions
- 04 **Range 802 LifeSystem**  
The Professional System for Care
- 10 **Range 477/801**  
The Classic in the Project
- 16 **System 800 K**  
Colours & Care
- 22 **System 800**  
Comfort to Care
- 28 **Range 805 Classic**  
The Public System
- 32 **Planning Service**
- 38 **Service**

## Philosophy Accessible Solutions

We believe HEWI high quality Accessible Solutions provide durable, aesthetic and stylish products which can be simply matched to the individual needs.

The HEWI Accessible Solutions utilises an unobtrusive design principle which allows the multi use railing systems, in conjunction with the removable hanging seat, to deliver the highest comfort, safety, hygiene and patient handling requirements which makes it easy for both users and carers to adapt the layout according to their specific requirements.

HEWI detailed systems also capture the clever use of colour and mixture of product textures which can be incorporated across the entire range which is very useful in the support of orientation and zone identification.

Many organisations comment on their increased demands to provide care for people with different needs – the Future Proofing of your bathrooms will provide you with total flexibility, therefore maximising on the HEWI System's versatility whatever the size or shape of the bathroom.

This flexibility also supports the independence of users, which in turn allows the care staff resources to be used effectively wherever required.

The extensive range of shower seats, railings, and accessories, are complimented by the iconic HEWI Door Hardware and Handrails & Balustrades Solutions, offering you an unparalleled consistent design throughout the building.

HEWI products are silent, unobtrusive helpers, which enable comfort, convenience and accessibility to become natural givens.



# Range 802 LifeSystem

## The Professional System for Care

LifeSystem focuses on the client's needs intuitively, regardless of physical and mental abilities. Adaptable, extendable and flexible products promote their users independence and mobility without neglecting aesthetic design. Form and function are united in LifeSystem. The sanitary system offers comfort, convenience and safety in equal measures. Function, flexibility, easy maintenance and robustness support the care personnel in their day-to-day work and therefore make LifeSystem the professional system for care. The system's modularity enables individual solutions.

### PRODUCT PROPERTIES

Flexibly usable professional system for the institutional care sector. LifeSystem offers a unique modular concept.

### AREAS OF USE

LifeSystem provides support in institutional care for the washbasin, WC and shower / bath areas.

### MATERIAL

Contact surfaces made of high-quality polyamide, supporting elements made of high-quality metal, seats and shelf surfaces made of PUR.

### DESIGN

Noa Produktdesign, Aachen

### AWARDS

red dot award: product design 2003



reddot design award  
winner 2003

### WASHBASIN AREA

Washbasin	950.11.101
Mirror	950.01.100
Holder / tumbler	477.00.100 / 477.04.020
Shower stool	802.51.W300
Towel ring	477.09.300
Shelf	802.03.W110L/802.03.W110R
Walking aid holder	802.90.600
Hook	801.90.010

### SHOWER AREA





L-shaped support rail with shower head holder	802.33.21090
Hinged seat Comfort	802.51.W210
Storage box	802.03.200
Hooks	477.90.045
Hook	801.90.010











# Range 802 LifeSystem Product Range





**MATERIAL AND SURFACES**  
 ■ Chrome  
 □ Polyamide / 98 (signal white)  
 ■ Polyamide / 97 (light grey)  
 ■ Polyamide / 92 (anthracite grey)  
 ■ Polyamide / 33 (ruby red)

**INSERTS**  
 ○ Polyamide / 98 (signal white)  
 ● Polyamide / 92 (anthracite grey)

 <b>Holder</b> W 78 x H 20 x D 91 mm W 81 x H 20 x D 92 mm 800.00.100... ■ ■	 <b>Tumbler</b> Ø 69, H 110 mm 800.04.0100 ... ○ ●	 <b>Soap dispenser</b> Ø 69, H 170 mm 800.06.010 ... ○ ●	 <b>Holder</b> W 122 x H 20 x D 90 mm W 125 x H 20 x D 92 mm 800.02.100... □ ■	 <b>Soap dish</b> W 113 x H 15 x D 68 mm 800.02.01001 ○ ●
---	---	---	---	--

 <b>Hooks</b> D 50 / 80 mm 800.90.010... / 800.90.020... □ ■ ■	 <b>Soap dispenser</b> W 70 x H 208 x D 122 mm 800.06.10090 □ ● Pushbutton	 <b>All-purpose dish</b> W 250 x H 20 x D 106 mm 800.03.200 ... □ ■ ○ ●	 <b>Shelf</b> W 600 x H 26 x T 140 mm 800.03.10090 □
---	--	---	---

 <b>Walking aid holder</b> Ø 150, T 146 mm 802.90.600 ■ □ ■ ■ ■	 <b>Shelf</b> B 434 x H 220 x T 151 mm 802.03... 110 ... ■ □ ■ ■ ■	 <b>Grab bar with backplate</b> B 187 x H 220 x T 93 mm 802.03... 120 ... ■ □ ■ ■ ■	 <b>Shelf</b> B 710 x H 220 x D 151 mm 802.03... 100 ■ □ ■ ■ ■
---	---	--	--

 <b>Toilet brush unit</b> W 130 x H 575 x D 140 mm 802.20.100 ■ □ ■ ■ ■	 <b>Toilet brush unit</b> W 105 x H 543 x D 120 mm W 105 x H 540 x D 120 mm 800.20.200 ... □ ■ ○ ●	 <b>Toilet roll holder, foldaway</b> W 140 x H 90 x D 20 mm 800.21.11090 □ ■	 <b>Spare roll holder</b> Ø 33, D 115 mm Ø 20, D 122 mm 800.21.300 ... □ ■	 <b>Towel rail</b> W 160 x L 445, Ø 28 mm 800.09.10090 □
---	--	---	--	---

 <b>Washbasin</b> W 600 x H 100 x D 550 mm W 450 x H 95 x D 400 mm 950.11.101 / 950.11.50... Mineral composite	 <b>Washbasin</b> W 850 x H 110 x D 415 mm 950.11.20 ... Mineral composite	 <b>Washbasin</b> W 1000 x H 130 x D 550 mm 950.11.40 ... Mineral composite
--	---	--

 <b>Adjustable mirror</b> W 725 x H 741 x D 73 mm 802.01.100 ... ■ □ ■ ■ ■ Handle	 <b>Mirror</b> W 1200 x H 600 mm W 1000 x H 570 mm 950.01.1... Float glass	 <b>Mirror</b> W 600 x H 600 mm 950.01.400 Float glass	 <b>Mirror</b> Ø 600 mm Ø 700 mm 950.01.3 ... Float glass
---	---	--	--

 <b>Paper towel dispenser</b> W 310 x H 459 x D 160 mm 800.06.60095 □	 <b>Paper towel basket</b> W 305 x H 515 x D 300 mm 800.05.20091 □	 <b>Waste bin</b> Ø 180, H 330 x D 210 mm 800.05.10090 □	 <b>Wastepaper bin</b> W 300 x H 510 x D 185 mm 950.05.110 White coated stainless steel
--	---	---	--

 <b>Soap dispenser</b> W 95 x H 275 x D 105 mm 950.06.100 White coated stainless steel	 <b>Paper towel dispenser</b> W 300 x H 360 x D 135 mm 950.06.500 White coated stainless steel	 <b>Hygiene combination</b> W 160 x H 300 x D 140 mm 950.05.210 White coated stainless steel	 <b>Hygiene waste bin</b> W 160 x H 300 x D 140 mm 950.05.200 White coated stainless steel
---	---	---	---

# Range 802 LifeSystem Product Range

### MATERIAL AND SURFACES

- Chrome
- Polyamide / 98 (signal white)
- Polyamide / 97 (light grey)
- Polyamide / 92 (anthracite grey)
- Polyamide / 33 (ruby red)

### PUR ELEMENTS

- PUR / 98 (signal white)
- PUR / 97 (light grey)
- PUR / 92 (anthracite grey)
- Polyamide / 33 (ruby red)

### INSERTS

- Polyamide / 98 (signal white)



<p><b>Support rail</b> L 300 / 400 / 600 / 900 mm 802.36.1 ...</p> <p>□ ■ Roses</p>	<p><b>Support rail</b> L 600 802.36.33090</p> <p>□ ■ Roses</p>	<p><b>Support rail</b> L 656 x H 232, angle 135° 802.22.20090</p> <p>□ ■ Roses</p>	<p><b>L-shaped support rail</b> L 600 x H 300 mm 802.22.10090</p> <p>□ ■ Roses</p>
---	--	--	--



<p><b>Rail with shower head holder</b> L 600 / 900 / 1100 mm 802.33.1 ...</p> <p>□ ■ Roses</p>	<p><b>L-shaped support rail with shower head holder</b> 1100 x 600 mm / 900 x 400 mm 802.33.2 ...</p> <p>□ ■ Roses</p>	<p><b>Rail with vertical support bar and shower head holder</b> 1100 x 762 x 762 mm 802.35.21090</p> <p>□ ■ Roses</p>	<p><b>Rail with vertical support bar and shower head holder</b> 1100 x 762 x 762 mm 802.35.31090</p> <p>□ ■ Roses</p>
--	--	---	---



<p><b>Shower grab rail</b> 762 x 762 mm 802.35.11090</p> <p>□ ■ Roses</p>	<p><b>Shower curtain rail</b> L 1000 mm 802.34.0100</p> <p>■ ○ Curtain rings</p>	<p><b>Shower curtain rail</b> L1 x L1 L1 = 988 / 1188 / 1488 / 1988 mm 802.34.1 ...</p> <p>■ ○ Curtain rings</p>
---	--	--



<p><b>Free-standing spray guard</b> max. W 1080 x H 950 mm 802.52.10030</p> <p>■</p>	<p><b>Shower spray guard</b> W 79 x H 950 x D 900 mm 802.52.200 ...</p> <p>■ □ ■ ■</p>	<p><b>Storage box</b> W 200 x H 110 x D 107 mm 802.03.200</p> <p>□ ■ ■ ■</p>	<p><b>Corner shelf</b> L 210 x L 210 x H 120 mm 802.03.210</p> <p>□ ■ ■ ■</p>
--	--	--	---



<p><b>Basic hinged seat</b> W 444 x H 317 x D 455 mm 802.51 ... 200 ...</p> <p>○ ● ●</p>	<p><b>Comfort hinged seat</b> W 444 x H 420 x D 455 mm 802.51 ... 210 ...</p> <p>○ ● ●</p>	<p><b>Premium hinged seat</b> W 620 x H 420 x D 455 mm 802.51 ... 220 ...</p> <p>○ ● ●</p>
--	--	--



<p><b>Shower stool</b> W 533 x H 531 x D 400 mm 802.51 ... 300 ...</p> <p>○ ● ●</p>	<p><b>Hanging seat Comfort</b> W 444 x H 498 x D 567 mm 802.51 ... 110 ...</p> <p>○ ● ●</p>	<p><b>Hanging seat Premium</b> W 620 x H 548 x D 567 mm 802.51 ... 120 ...</p> <p>○ ● ●</p>
---	---	---



<p><b>Hinged support rail</b> L 650 / 700 / 750 / 800 / 850 / 900 mm 802.50 ...</p> <p>■ ○ ● ● ●</p>	<p><b>Upgrade kit toilet roll holder</b> W 33 x H 145 x D 117 mm 802.50 ... 010</p> <p>□</p>	<p><b>Upgrade kit WC flushing mechanism</b> W 50 x H 400 mm 802.50 ... 060 ...</p> <p>□</p>
--	--	---



<p><b>Back rest rail</b> L 630 - 730 mm 802.50.070 ...</p> <p>■ ○ ● ●</p>
---

# Range 477/801

## The Classic in Project

HEWI developed Range 801 in the nineteen eighties and with it launched the first sanitary accessibility product range on the market. Since then the range has been continuously developed further and has established itself as a classic, which guarantees universal accessibility. With Range 477, HEWI supplies sanitary accessories suitable for the accessibility Range 801. Due to its timeless design and comprehensive projects product portfolio, the ranges are today still among the most frequently used for accessible sanitary facilities. Use of colour enables contrasts to be created and facilitates orientation.

### PRODUCT PROPERTIES

This Sanitary range can be used universally due to the modularity of the products and enables an accessible sanitary fit out.

### AREAS OF USE

Due to its functions and consistent design, the range is particularly suitable for the institutional care sector.

### MATERIAL

The accessibility products consist of through-dyed polyamide with corrosion-proof steel core, the accessories of the range are made of through-dyed polyamide.

### DESIGN

HEWI, Bad Arolsen

### AWARDS

if product design award 1987



### WASHBASIN AREA

Washbasin	950.11.101
Mirror	950.01.100
Support rail (500 mm)	801.36.120
Holder / tumbler	477.00.100 / 477.04.020
Soap dispenser	477.06.10005
Hooks	477.90.010
Waste bin	477.05.100

### SHOWER AREA

Rail with vertical support bar	801.35.300
Removable hanging seat	802.51.W110
Storage box	802.03.200
Shower curtain rail	801.34.110
Ceiling support	801.34.021
Shower curtain	802.34.01030







# Range 477/801 Product Range





**MATERIAL AND SURFACES**  
■ Polyamide / 13 (buttercup yellow)  
■ Polyamide / 33 (ruby red)  
■ Polyamide / 30 (burgundy)  
■ Polyamide / 53 (ultramarine blue)  
■ Polyamide / 50 (steel blue)





□ Polyamide / 99 (pure white)  
■ Polyamide / 97 (light grey)  
■ Polyamide / 95 (stone grey)  
■ Polyamide / 92 (anthracite grey)  
■ Polyamide / 90 (jet black)

**INSERTS**  
● Glass, matt white

				
<b>Holder</b> W 97 x H 25 x D 100 mm 477.00.100	<b>Tumbler</b> Ø 74, H 80 mm 477.04.020	<b>Soap dish insert</b> Ø 74, H 25 mm 477.02.01005	<b>Soap dispenser</b> W 70 x H 208 x D 122 mm 477.06.10005	<b>Soap dish</b> W 120 x H 25 x D 120 mm 477.02.200
Available in HEWI colours	Available in HEWI colours	<span style="color: blue;">●</span>	Available in HEWI colours	Available in HEWI colours

			
<b>Storage dish</b> W 250 x H 35 x D 115 mm 477.03.300	<b>Shelf</b> W 600 x H 26 x D 140 mm 477.03.100	<b>Mirror clip</b> W 30 x H 60 x D 18 mm 477.01.100	<b>Single hook / Double coat hook</b> Ø 50, D 45 mm Ø 50, D 43.5 mm 477.90.010 / 477.90.025
Available in HEWI colours	Available in HEWI colours	Available in HEWI colours	Available in HEWI colours



				
<b>Toilet brush unit</b> W 141 x H 470 x D 140 mm 477.20.100	<b>Toilet brush unit</b> W 130 x H 575 x D 140 mm 801.20.100	<b>Toilet roll holder</b> W 160 x H 120, Ø 20 mm 477.21.100	<b>Toilet roll holder</b> Ø 70, D 121 mm 801.21.300	<b>Spare roll holder</b> Ø 70, D 120 mm 477.21.200
Available in HEWI colours	Available in HEWI colours	Available in HEWI colours	Available in HEWI colours	Available in HEWI colours

			
<b>Towel rail</b> H 160 x D 445, Ø 28 mm 477.09.100	<b>Towel ring</b> W 320 x H 150, Ø 28 mm 477.09.300	<b>Towel rail</b> L 457 / 570 / 600 / 800 / 1000 / 1100 mm 477.30...	<b>Corner shelf</b> W 205 x H 37 x D 205 mm 477.32.100
Available in HEWI colours	Available in HEWI colours	Available in HEWI colours	Available in HEWI colours

			
<b>Removable hanging seat</b> W 345 x H 400 x D 480 mm / W 448 x H 395 x D 500 mm 801.51.1 ...	<b>Hinged seat</b> W 345 x H 259 x D 408 mm / W 448 x H 259 x D 428 mm 801.51.2 ...	<b>Stool</b> W 345 x H 500 x D 336 mm 801.51.300	<b>Back rest rail</b> L 670 – 730 mm 801.51.900
Available in HEWI colours	Available in HEWI colours	Available in HEWI colours	Available in HEWI colours

			
<b>Support rail</b> L 300 / 400 / 500 / 600 / 800 / 900 / 1000 / 1100 mm 801.36.1 ...	<b>Support rail</b> W 620 x H 200 mm, angle 135° 801.22.200	<b>L-shaped support rail</b> 600 x 300 mm / 900 x 400 mm 801.22.1 ...	<b>Floor to wall stationary support</b> W 834 x H 850 x D 135 mm 801.22.400
Available in HEWI colours	Available in HEWI colours	Available in HEWI colours	Available in HEWI colours

		
<b>Stationary support rail</b> L 600 / 700 / 850 mm 801.50.3 ...	<b>Hinged support rail</b> L 600 / 700 / 850 / 900 mm 801.50.2 ...	<b>Hinged support rail, rotating</b> L 600 / 700 / 850 / 900 mm 801.50.1 ...
Available in HEWI colours	Available in HEWI colours	Available in HEWI colours

	
<b>Upgrade kit toilet roll holder</b> W 35 x H 131 x D 136 mm 801.50.010	<b>Upgrade kit WC flushing mechanism (radio-controlled)</b> W 50 x H 68 x D 105 mm 801.50.060
Available in HEWI colours	Available in HEWI colours

# Range 477/801 Product Range

### MATERIAL AND SURFACES

- Polyamide / 13 (buttercup yellow)
- Polyamide / 33 (ruby red)
- Polyamide / 30 (burgundy)
- Polyamide / 53 (ultramarine blue)
- Polyamide / 50 (steel blue)

- Polyamide / 99 (pure white)
- Polyamide / 97 (light grey)
- Polyamide / 95 (stone grey)
- Polyamide / 92 (anthracite grey)
- Polyamide / 90 (jet black)

### SEATS

- Polyamide / 98 (signal white)
- Polyamide / 92 (anthracite grey)

### WALL BRACKET

- White
- Chrome



**Rail with shower head holder**  
L 600 / 900 / 1100 mm  
801.33.1...

Available in HEWI colours



**L-shaped support rail with shower head holder**  
1100 x 600 mm  
801.33.210

Available in HEWI colours

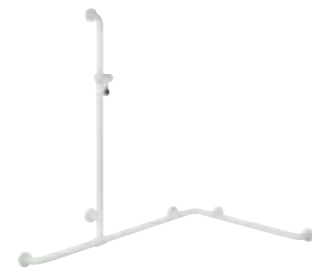

**Rail with vertical support bar and shower head holder**  
1100 x 762 x 762 mm /  
1100 x 962 x 962 mm  
801.35.3 ...

Available in HEWI colours



**Rail with vertical support bar and shower head holder**  
1100 x 962 mm  
801.35.410

Available in HEWI colours



**Washbasin**  
W 600 x H 100 x D 550 mm  
W 450 x H 95 x D 400 mm  
950.11.101 / 950.11.50 ...

Mineral composite



**Washbasin**  
W 850 x H 110 x D 415 mm  
W 1000 x H 130 x D 550 mm  
950.11.20 ... / 950.11.40 ...

Mineral composite



**Washbasin**  
W 600 x H 100 x D 450 mm /  
W 600 x H 120 x D 500 mm  
950.11.300 / 950.11.30 ...

Mineral composite



**Shower curtain rail**  
L 1000 mm  
801.34.400

Available in HEWI colours



**Shower curtain rail**  
L1 x L1  
L1 = 783 / 883 / 983 / 1183 / 1483 mm  
801.34.1...

Available in HEWI colours



**Shower curtain rail**  
L1 x L2 x L1  
L1 = 983 / 1183 / 1483 mm  
L2 = 976 / 1167 / 1467 mm  
801.34.3 ...

Available in HEWI colours



**Ceiling support**  
L 300 / 400 / 500 / 600 mm  
801.34.0 ...

Available in HEWI colours



**Adjustable mirror**  
W 580 x H 680 x D 115 mm  
800.01.10060

Available in HEWI colours



**Mirror**  
W 1200 x H 600 mm  
W 1000 x H 570 mm  
950.01.100

Float glass



**Mirror**  
W 600 x H 600 mm  
950.01.400

Float glass



**Mirror**  
Ø 600 mm  
Ø 700 mm  
950.01.3 ...

Float glass

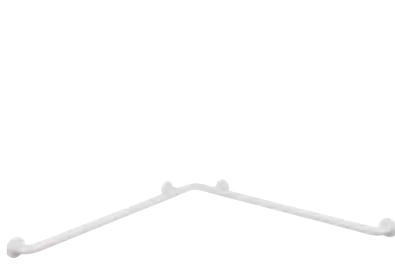

**Shower grab rail**  
762 x 762 mm / 962 x 962 mm  
801.35.1 ...

Available in HEWI colours



**Shower spray guard**  
W 78 x H 967 x D 940 mm  
801.52.100 ...

Available in HEWI colours



**Storage box**  
W 200 x H 110 x D 107 mm  
802.03 200

Available in HEWI colours



**Waste bin**  
Ø 180, H 330 x D 210 mm  
477.05 100

Available in HEWI colours



**Hinged seat R 380**  
W 380 x H 110 x D 407 mm  
950.51.22 ...

Available in HEWI colours

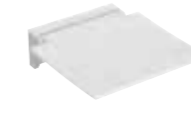

**Hinged seat 350**  
W 350 x H 110 x D 373 mm  
950.51.20 ...

Available in HEWI colours



**Hinged seat 450**  
W 450 x H 110 x D 463 mm  
950.51.21 ...

Available in HEWI colours



**Backrest**  
W 350 x H 395 x D 45 mm  
950.51.02090

Available in HEWI colours



**Paper towel dispenser**  
W 310 x H 459 x D 160 mm  
477.06.60005

Available in HEWI colours



**Paper towel basket**  
W 305 x H 515 x D 300 mm  
477.05.2001 ...

Available in HEWI colours



**Adjustable mirror**  
W 600 x H 540 mm  
801.01.100

Handle available in HEWI colours



**Plate glass mirror**  
W 600 x H 1200 mm  
801.01.300

Holder available in HEWI colours



**Removable hanging seat 350**  
W 350 x H 449 x D 469 mm  
950.51 11...

Available in HEWI colours



**Removable hanging seat 450**  
W 450 x H 503 x D 560 mm  
950.51.10...

Available in HEWI colours



# System 800 K Colours & Care

The clear style and characteristically large radii of System 800 is also reflected in the 800 K material variation. A brilliant, high-gloss surface and the deliberate use of colour are the outstanding features of System 800 K. As the system's basic colour, signal white can be combined with coloured accents in orange, apple green or anthracite grey. Manufactured in high quality polyamide, the products are scratch and impact resistant with a non-porous surface which is hygienic and easy to clean. Thanks to their fracture resistance, easy care and warm touch synthetic material, the sanitary products are especially suitable for kindergartens, retirement homes and hospitals.

The use of vibrant colours such as orange, apple green and anthracite grey follows both design aspects as well as functional criteria. Colour not only sets accents in a room, but it also creates orientation.

#### PRODUCT PROPERTIES

The specific colour accents characterise System 800 K and create contrasts. The system's modularity enables its universal use.

#### AREAS OF USE/DESIGN

System 800 K is suitable for kindergartens or institutional care facilities, for example, retirement homes and hospitals.

#### MATERIAL

Polyamide

#### DESIGN

Phoenix Design, Stuttgart/Tokyo

## WASHBASIN AREA

Washbasin	950.11.101
Adjustable mirror	800.01.10060
All-purpose dish	800.03.20093
Waste bin	800.05.10090
Support rail (600 mm)	950.36.13091
Soap dispenser	800.06.10093
Tumbler / holder	800.04.01003/800.00.10090

## SHOWER AREA





Shower basket	800.03.30092
Rail with shower head holder (1100 mm)	950.33.12092
Hinged seat 450 / backrest	950.51.21090 / 950.51.02090
Soap dispenser	800.06.10092
Support rail (600 mm)	950.36.13091



# System 800 K Product Range



**MATERIAL AND SURFACES**  
 Polyamide / 98 (signal white)  
 Polyamide / 92 (anthracite grey)  
 Polyamide / 24 (orange)  
 Polyamide / 74 (apple green)





**INSERTS**  
 Polyamide / 98 (signal white)  
 Polyamide / 92 (anthracite grey)  
 Polyamide / 24 (orange)  
 Polyamide / 74 (apple green)

				
<b>Holder</b> W 78 x H 20 x D 91 mm 800.00.10090	<b>Tumbler</b> Ø 69, H 110 mm 800.04.0100 ...	<b>Soap dispenser</b> Ø 69, H 170 mm 800.06.010 ...	<b>Holder</b> W 122 x H 20 x D 90 mm 800.02.10090	<b>Soap dish</b> W 113 x H 15 x D 68 mm 800.02.0100 ...
<input type="checkbox"/>	<input type="checkbox"/> <input checked="" type="checkbox"/> <input checked="" type="checkbox"/> <input checked="" type="checkbox"/>	<input type="checkbox"/> <input checked="" type="checkbox"/> <input checked="" type="checkbox"/> <input checked="" type="checkbox"/>	<input type="checkbox"/>	<input type="checkbox"/> <input checked="" type="checkbox"/> <input checked="" type="checkbox"/> <input checked="" type="checkbox"/>

		
<b>Washbasin</b> W 600 x H 100 x D 550 mm W 450 x H 95 x D 400 mm 950.11.101 / 950.11.50 ...	<b>Washbasin</b> W 850 x H 110 x D 415 mm W 1000 x H 130 x D 550 mm 950.11.20 ... / 950.11.40 ...	<b>Washbasin</b> W 600 x H 100 x D 450 mm / W 600 x H 120 x D 500 mm 950.11.300 / 950.11.30 ...
Mineral composite	Mineral composite	Mineral composite

			
<b>Soap dispenser</b> W 70 x H 208 x D 122 mm 800.06.1009 ...	<b>All-purpose dish</b> W 250 x H 20 x D 106 mm 800.03.2009 ...	<b>Shelf</b> W 600 x H 26 x D 140 mm 800.03.10090	<b>Mirror clip</b> W 30 x H 60 x D 18 mm 800.01.10090
<input type="checkbox"/> <input checked="" type="checkbox"/> <input checked="" type="checkbox"/> <input checked="" type="checkbox"/> Pushbutton	<input type="checkbox"/> <input type="checkbox"/> <input checked="" type="checkbox"/> <input checked="" type="checkbox"/> <input checked="" type="checkbox"/>	<input type="checkbox"/>	<input type="checkbox"/>

			
<b>Adjustable mirror</b> W 580 x H 680 x D 115 mm 800.01.10060	<b>Mirror</b> W 1200 x H 600 mm W 1000 x H 570 mm 950.01.100	<b>Mirror</b> W 600 x H 600 mm 950.01.400	<b>Mirror</b> Ø 600 mm Ø 700 mm 950.01.3 ...
	Float glass	Float glass	Float glass

				
<b>Hooks</b> D 50 / 80 mm 800.90.01090 / 800.90.02090	<b>Toilet brush unit</b> W 105 x H 543 x D 120 mm 800.20.2009 ...	<b>Toilet roll holder, foldaway</b> W 140 x H 90 x D 20 mm 800.21.11090	<b>Spare roll holder</b> Ø 33, D 115 mm 800.21.30090	<b>Towel rail</b> H 160 x L 445, Ø 28 mm 800.09.10090
<input type="checkbox"/> <input checked="" type="checkbox"/> <input checked="" type="checkbox"/> <input checked="" type="checkbox"/>	<input type="checkbox"/> <input type="checkbox"/> <input checked="" type="checkbox"/> <input checked="" type="checkbox"/> <input checked="" type="checkbox"/>	<input type="checkbox"/>	<input type="checkbox"/>	<input type="checkbox"/>

			
<b>Cosmetic mirror</b> Ø 210, D 85 mm 950.01.20090	<b>Paper towel dispenser</b> W 310 x H 459 x D 160 mm 800.06.60095	<b>Paper towel basket</b> W 305 x H 515 x D 300 mm 800.05.20091	<b>Waste bin</b> Ø 180, H 330 x D 210 mm 800.05.10090
<input type="checkbox"/> <input type="checkbox"/> <input checked="" type="checkbox"/> <input checked="" type="checkbox"/> <input checked="" type="checkbox"/> Outer ring	<input type="checkbox"/>	<input type="checkbox"/>	<input type="checkbox"/>

				
<b>Paper tissue dispenser</b> W 250 x H 80 x D 130 mm 950.06.20090	<b>Towel ring</b> W 320 x H 150, Ø 28 mm 800.09.30090	<b>Grab bar</b> L 250 mm 800.31.11090	<b>Towel rail</b> L 570 mm 800.30.11090	<b>Shower basket</b> W 250 x H 90 x D 106 mm 800.03.3009 ...
<input type="checkbox"/>	<input type="checkbox"/>	<input type="checkbox"/>	<input type="checkbox"/>	<input type="checkbox"/> <input type="checkbox"/> <input checked="" type="checkbox"/> <input checked="" type="checkbox"/> <input checked="" type="checkbox"/>

# System 800 K Product Range

**MATERIAL AND SURFACES**  
□ Polyamide / 98 (signal white)

**INSERTS**  
○ Polyamide / 98 (signal white)  
● Polyamide / 92 (anthracite grey)  
● Polyamide / 24 (orange)  
● Polyamide / 74 (apple green)

**WALL BRACKET**  
△ White  
▲ Chrome-look coated



**Stationary support rail Mono**  
L 600 mm  
950.50.310 ...



**Stationary support rail Duo**  
L 700 / 850 mm  
950.50.3 ...



**Hinged support rail Mono**  
L 600 mm  
950.50.110 ...



**Hinged support rail Duo**  
L 700 / 850 / 900 mm  
950.50.1 ...



**Upgrade kit toilet roll holder with WC flushing mechanism and function button (radio-controlled)**  
W 35 x H 122.5 x D 149 mm  
950.50.06 ...



**Upgrade kit toilet roll holder**  
W 35 x H 122.5 x D 149 mm  
950.50.01090



**Floor support**  
L 643 ± 20 mm  
950.50.02092

Stainless steel



**Hinged seat R 380**  
W 380 x H 110 x D 407 mm  
950.51.20 ...



**Hinged seat 350**  
W 350 x H 110 x D 373 mm  
950.51.20 ...



**Hinged seat 450**  
W 450 x H 110 x D 463 mm  
950.51.21 ...



**Backrest**  
W 350 x H 395 x D 45 mm  
950.51.02090



**Removable hanging seat 350**  
W 350 x H 449 x D 469 mm  
950.51.11 ...



**Removable hanging seat 450**  
W 450 x H 503 x D 560 mm  
950.51.10 ...



**Support rail**  
L 300 / 400 / 600 / 900 mm  
950.36.1 ...

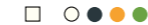

Grab rail



**Support rail**  
L 600 mm  
950.36.3309 ...



Grab rail



**Support rail**  
L 656 x H 232 / angle 135°  
950.22.20090



**L-shaped support rail**  
W 300 x H 600 mm  
950.22.10090



**Shower grab rail**  
762 x 762 mm  
950.35.11090



**Rail with shower head holder**  
L 600 / 900 / 1100 mm  
950.33.1 ...



**L-shaped support rail with shower head holder**  
400 x 900 mm / 600 x 1100 mm  
950.33.2 ...



**Rail with vertical support rail and shower head holder**  
W 762 x H 1100 x D 762 mm  
950.35.3109 ...



**Rail with vertical support bar and shower head holder**  
W 762 x H 1100 x D 762 mm  
950.35.2109 ...

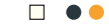

**Shower curtain rail**  
L 1000 mm  
800.34.400



**Shower curtain rail**  
L1 x L1  
L1 = 783 / 883 / 983 / 1183 / 1483 mm  
800.34.1 ...



**Shower curtain rail**  
L1 x L2 x L1  
L1 = 986 / 1186 / 1486 mm  
L2 = 967 / 1167 / 1467 mm  
800.34.3 ...



**Ceiling support**  
L 300 / 400 / 500 / 600 mm  
800.34.0 ...



# System 800

## Comfort to Care

System 800 stands for aesthetic ease in the bathroom. The reduced, clear design of System 800 is determined by its harmonious style with large radii and high-quality materials, thus making the products durable and, therefore, sustainable.

Material options offer diverse design possibilities: The holder elements are available with a fine chrome surface and can be combined with inserts made of satin-finished glass or high quality polyamide. The highly acclaimed System 800 design not only impresses with its visual appearance, but also with its functionality.

### PRODUCT PROPERTIES

Sanitary system, whose outstanding features are its well thought through, functional product details. For example, the inlays of the shelves can be rotated and depending on the needs can be used as a flat shelf or as a dish.

### AREAS OF USE

Home, home care, high-class business premises and hotels – the system can be used to fit out the washbasin, WC, shower and bath areas, and can be supplemented with accessibility products.

### MATERIAL

Chrome-plated holder with optional inserts made of polyamide or satin-finished glass.

### AWARDS

Nomination – Design Prize of the Federal Republic of Germany 2011  
iF product design award 2010  
universal design award:  
consumer favorite 2010  
IFA Usability Park Public Prize 2010

### DESIGN

Phoenix Design, Stuttgart/Tokyo



## WASHBASIN AREA

Washbasin	950.11.101
Mirror	950.01.100
All-purpose dish	800.03.20041
Tumbler, polyamide / holder	800.04.01001 / 800.00.10040
Support rail (400 mm)	950.36.61040
Stool	800.51.30041

## TOILET AREA

Toilet brush unit	800.20.20041
Toilet roll holder, foldaway	800.21.11040
Support rail (600 mm)	800.36.11040
Mono hinged support rail (600 mm)	950.50.61040



# System 800 Product Range





**MATERIAL AND SURFACES**

■ Chrome

**INSERTS**

● Satin-finished crystal glass

○ Polyamide / 98 (signal white)

				
<b>Holder</b> W 81 x H 20 x D 92 mm 800.00.10040	<b>Tumbler</b> Ø 69, H 110 mm 800.04.0100 ...	<b>Soap dispenser</b> Ø 69, H 168 mm 800.06.0104 ...	<b>Holder</b> W 125 x H 20 x D 92 mm 800.02.10040	<b>Soap dish</b> W 113 x H 15 x D 68 mm 800.02.0100 ...
■	● ○	● ○	■	● ○

		
<b>Washbasin</b> W 600 x H 100 x D 550 mm W 450 x H 95 x D 400 mm 950.11.101 / 950.11.50 ...	<b>Washbasin</b> W 850 x H 110 x D 415 mm W 1000 x H 130 x D 550 mm 950.11.20 ... / 950.11.40 ...	<b>Washbasin</b> W 600 x H 100 x D 450 mm / W 600 x H 120 x D 500 mm 950.11.300 / 950.11.30 ...
Mineral composite	Mineral composite	Mineral composite

			
<b>All-purpose dish</b> W 250 x H 20 x D 106 mm 800.03.20041	<b>Shelf</b> W 600 x H 20 x D 100 mm 800.03.100 ...	<b>Hooks</b> D 50 / 80 mm 800.90.01040 / 800.90.02040	<b>Towel rail</b> W 73 x H 30 x D 477 mm 800.09.10040
■ ○	■ ● ○	■	■

			
<b>Adjustable mirror</b> W 580 x H 680 x D 115 mm 800.01.10060	<b>Mirror</b> W 1200 x H 600 mm W 1000 x H 570 mm 950.01.100	<b>Mirror</b> W 600 x H 600 mm 950.01.400	<b>Mirror</b> Ø 600 mm Ø 700 mm 950.01.3 ...
	Float glass	Float glass	Float glass

				
<b>Toilet brush unit</b> W 105 x H 420 x D 120 mm 800.20.1004 ...	<b>Toilet brush unit</b> W 105 x H 540 x D 120 mm 800.20.20041	<b>Toilet roll holder, foldaway</b> W 140 x H 90 x D 20 mm 800.21.11040	<b>Spare roll holder</b> Ø 20, D 122 mm 800.21.30040	<b>Stool</b> W 400 x H 460 x D 400 mm 800.51.30041
■ ● ○	■ ○	■	■	■

			
<b>Wastepaper bin</b> W 300 x H 510 x D 185 mm 950.05.100	<b>Wastepaper bin with lid</b> W 300 x H 510 x D 185 mm 950.05.110	<b>Hygiene waste bin</b> W 160 x H 300 x D 140 mm 950.05.200	<b>Hygiene combination</b> W 160 x H 300 x D 140 mm 950.05.210
White coated stainless steel	White coated stainless steel	White coated stainless steel	White coated stainless steel

				
<b>Paper tissue dispenser</b> W 250 x H 80 x D 130 mm 950.06.20050	<b>Support rail</b> L 300 / 600 / 900 mm 800.36.1 ...	<b>Towel rail</b> L 600 / 900 mm 800.30.1 ...	<b>Shower basket</b> W 250 x H 70 x D 106 mm 800.03.30041	<b>Rail with shower head holder</b> L 900 / 1100 mm 800.33.1 ...
■	■	■	■ ○	■

			
<b>Soap dispenser</b> W 95 x H 275 x D 105 mm 950.06.100	<b>Paper towel dispenser</b> W 300 x H 360 x D 135 mm 950.06.500	<b>Hygiene bag dispenser</b> W 150 x H 92 x D 37 mm 950.06.700	<b>Large toilet roll holder</b> W 365 x H 365 x D 140 mm 950.21.600
White coated stainless steel	White coated stainless steel	White coated stainless steel	White coated stainless steel

# System 800 Product Range

**MATERIAL AND SURFACES**

■ Chrome

**SEATS**

○ Polyamide / 98 (signal white)

● Polyamide / 92 (anthracite grey)

**WALL BRACKET**

△ White

▲ Chrome



**Mono hinged support rail**  
L 600 mm  
950.50.61040



**Duo hinged support rail**  
L 700 / 850 / 900 mm  
950.50.6...



**Back rest rail**  
L 350 / 390 / 150 mm  
950.51.90090



**Upgrade kit toilet roll holder with WC flushing mechanism and function button (radio-controlled)**  
W 35 x H 122.5 x D 149 mm  
950.50.06...



**Upgrade kit toilet roll holder**  
W 35 x H 122.5 x D 149 mm  
950.50.01150



**Arm pad**  
L 250 mm  
950.50.03192

Polyurethane



**Floor support**  
L 643 ± 20 mm  
950.50.02092

Stainless steel



**Shower curtain rail**  
L 1000 mm  
802.34.0100



**Shower curtain rail**  
L1 x L1  
L1 = 988 / 1188 / 1488 / 1988 mm  
802.34.1...



**Ceiling support**  
L 400 – 1500 mm  
802.34.02...



**Hinged seat R 380**  
W 380 x H 110 x D 407 mm  
950.51.22...

○ ● △ ▲



**Hinged seat 350**  
W 350 x H 110 x D 373 mm  
950.51.20...

○ ● △ ▲



**Hinged seat 450**  
W 450 x H 110 x D 463 mm  
950.51.21...

○ ● △ ▲



**Backrest**  
W 350 x H 390 x D 43.5 mm  
950.51.02090

○ ●



**Support rail**  
L 400 / 600 / 900 mm  
950.36.6...



**Rail with shower head holder**  
L 600 / 900 / 1100 mm  
950.33.6...

# Range 805 Classic

## The Public System

Clarity characterises Range 805. The material combination of satin finish stainless steel and high-quality polyamide, emphasises the functional design principle. The reduced style and modular structure of this range allows its universal use. With Range 805, an adaptive, sustainable room concept can be implemented. The range includes classic sanitary accessories as well as products with a light supporting effect, and products with complex accessibility functions for use in standardised, public areas as well as in the professional care sector.

### PRODUCT PROPERTIES

Sanitary range which, thanks to its comprehensive range of products, offers the right solution for every application. The range is particularly suitable for the public sector, as extreme robustness is one of the outstanding features of the products.

### AREAS OF USE

The range can be used in the private bathroom as well as in the public sector or in the institutional care sector. The portfolio includes products for the washbasin and toilet area as well as for the shower and bath.

### DESIGN

Noa Produktdesign, Aachen

### MATERIAL

Surface made of satin finish stainless steel; functional elements made of high-quality polyamide, optionally available in pure white or anthracite grey.

### AWARDS

iF award product design 2008  
red dot: product design 2008 – honourable mention



reddot design award  
honourable mention 2008

## TOILET AREA

Hinged support rail, rotating (700 mm)	805.50.110
Upgrade kit toilet roll holder	805.50.015
Toilet brush unit	805.20.100

## SHOWER AREA

Rail with vertical support bar and shower head holder	805.35.310
Storage box	802.03.200
Comfort removable hanging seat	802.51.11092
Shower curtain rail for shower trays	805.34.120
Ceiling support	805.34.020
Shower curtain, plain white	802.34.01030
Hooks	805.90.030



# Range 805 Classic Product Range

**MATERIAL AND SURFACES**

■ Satin finish stainless steel

**FUNCTIONAL AREAS / INSERTS**

○ Polyamide / 99 (pure white)

● Polyamide / 97 (light grey)

● Polyamide / 92 (anthracite grey)



**Toilet brush unit**  
W 141 x H 470 x D 140 mm  
805.20.100

■ ○ ●



**Toilet roll holder**  
W 160 x H 120, Ø 20 mm  
805.21.100

■



**Spare roll holder /  
Toilet roll holder**  
Ø 33, L 120  
805.21.200

■



**Hook**  
Ø 50, D 55 mm  
805.90.010 / 805.90.030

■



**L-shaped support rail**  
L 620 x H 200 mm, angle 135°  
805.22.200 ...

■



**L-shaped support rail**  
600 x 300 mm  
805.22.100 ...

■



**L-shaped support rail**  
900 x 400 mm  
805.22.110 ...

■



**Shower grab rail**  
762 x 762 mm  
805.35.110

■



**Stationary support rail**  
L 450 / 600 / 700 / 850 mm  
805.50.3 ...

■ ○ ●

Wall plate



**Hinged support rail**  
L 600 / 700 / 850 mm  
805.50.2 ...

■ ○ ●

Wall plate



**Hinged support rail, rotating**  
L 600 / 700 / 850 mm  
805.50.1 ...

■ ○ ●

Wall plate



**Hinged support rail**  
L 600 / 700 / 850 mm  
805.50.2 ...

■



**Rail with shower head holder**  
L 600 / 900 / 1100 mm  
805.33.1 ...

■ ○ ●



**L-shaped support rail with shower  
head holder**  
600 x 1100 mm  
805.33.210 ...

■ ○ ●

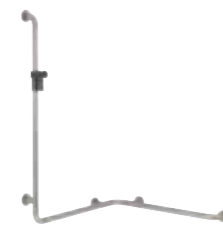

**Shower grab rail with vertical  
support bar and shower head holder**  
W 762 x H 1100 x D 762 mm  
805.35.210 ...

■ ○ ●

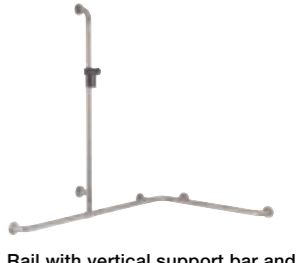

**Rail with vertical support bar and  
shower head holder**  
W 762 x H 1100 x D 762 mm  
W 1185 x H 1100 x D 762 mm  
805.35.3 ...

■ ○ ●



**Hinged support rail, rotating**  
L 600 / 700 / 850 / 900 mm  
805.50.1 ...

■



**Upgrade kit toilet roll holder**  
W 35 x H 131 x D 136 mm  
805.50.015

○ ●



**Upgrade kit WC flushing mechanism  
(radio-controlled)**  
W 50 x H 68 x D 105 mm  
805.50.060

○ ●



**Support rail**  
L 300 / 400 / 500 / 600 / 900 / 1100 mm  
805.36.1 ...

■



**Shower curtain rail**  
L 1000 mm  
805.34.200

■



**Shower curtain rail**  
L1 x L1  
L1 = 983 / 1183 / 1483 mm  
805.34.1 ...

■



**Ceiling support**  
L 400 / 500 / 600 mm  
805.34.02 ...

■



**Shower spray guard**  
W 940 x H 890 mm  
805.52.20030

■



**Removable hanging seat 350**  
W 350 x H 449 x D 469 mm  
950.51.11 ...

○ ●



**Removable hanging seat 450**  
W 450 x H 503 x D 560 mm  
950.51.10 ...

○ ●



**Back rest rail**  
L 670 - 730 mm  
805.51.900

■



**Comfort hinged seat**  
W 444 x H 420 x D 455 mm  
802.51 ... 210 ...

○ ● ●



**Premium hinged seat**  
W 620 x H 420 x D 455 mm  
802.51 ... 220 ...

○ ● ●



**Hanging seat Comfort**  
W 444 x H 498 x D 567 mm  
802.51 ... 110 ...

○ ● ●



## INCLUSIVE DESIGN

Inclusive design avoids stigmatisation because it's a design for all people. Universal product form is therefore the guiding principle of HEWI. The demands made on the planning, development and installation of "accessible buildings" have changed drastically. HEWI, as your reliable partner in the accessible living segment, has refined this topic over the years through selective measures, products and services. Know-how is in demand. And in addition, we offer a unique choice of products to provide you with professional and competent support for the fulfilment of your tasks.

## STANDARDS UNITED KINGDOM

BS 8300:2009

Design of buildings and their approaches to meet the needs of disabled people. Code of practice:

BS 8300 explains how the built environment can be designed to anticipate, and overcome, restrictions that prevent disabled people making full use of premises and their surroundings.

An accessible environment is one which a disabled person can enter and make use of independently or with help from a partner or assistant, including being able to escape in the event of fire or other emergency.

Some facilities can be designed in such a way as to incorporate access for disabled people. In other situations, additional features such as grab bars, touch legible signs and hearing enhancement systems might be needed.

The guidance in BS 8300 covers a wide range of disabilities and the use of the built environment by disabled people who can be residents, visitors, spectators, customers, employees, or participants in sports events, performances and conferences.

BS 8300 gives recommendations for the design of buildings and their approaches to meet the needs of disabled people (including, where appropriate, disabled children). It applies to car parking provision, setting-down points, garaging, access routes to and around all buildings, entrances to and interiors of new buildings. The recommendations also apply to routes to facilities associated with and in the immediate vicinity of buildings.

BS 8300 applies to the following types of buildings:

- a) Transport and industrial buildings
- b) Administrative and commercial buildings
- c) Health and welfare buildings
- d) Refreshment, entertainment and recreation buildings
- e) Buildings for worship
- f) Educational, cultural and scientific buildings
- g) Dwellings (for access routes only) and other residential buildings, e.g. hostels, hotels, residential clubs, university and college halls of residence, nursing homes and prisons.

# Functional Area Washbasin

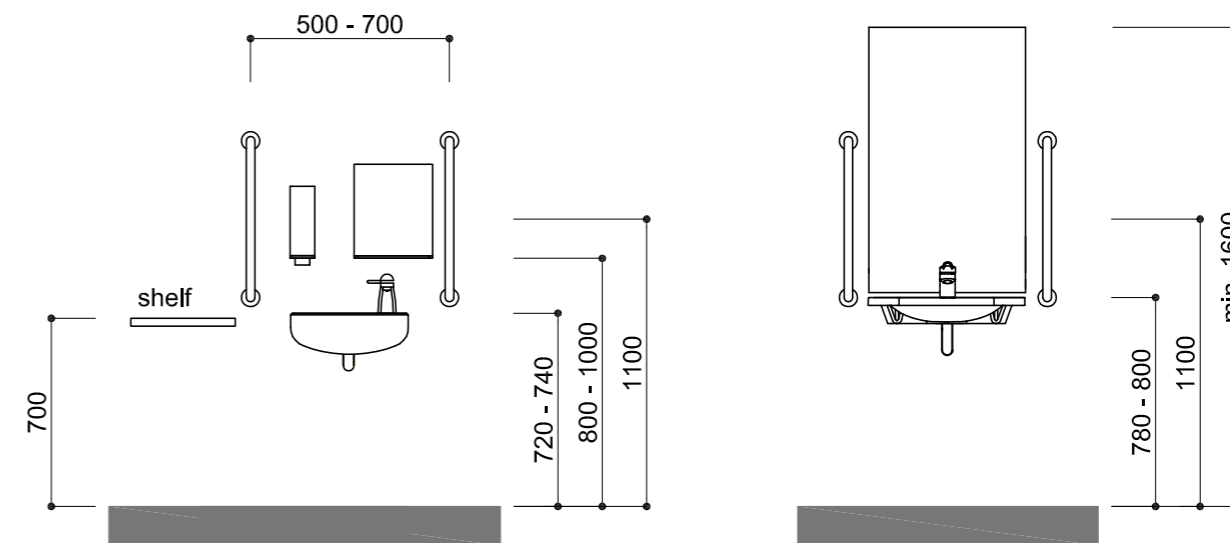

hand rinse washbasin

independent washbasin

## INSTALLATION RECOMMENDATIONS

## BS 8300:2009+A1:2010

Minimum room dimension	1500 x 2200 mm
Door	926 mm single-swing door
Wheelchair turning space	1500 x 1500 mm
Installation height hand rinse washbasin	Rim height at 720 to 740 mm
Grab rail	600 mm vertical grab rail Grab rail at each side of the mirror – distance 500-700 mm Centre line 1100 mm above floor level
Mirror suitable for seated and standing persons	Bottom Line 600 mm – top edge 1600 mm (located away from washbasin) Bottom line 1600 mm (located above washbasin)
Tilting mirror	If mirrors cannot be extended down to the upper edge of the washbasin, they should be tilted forward
Shelf	400 mm wide, 200 mm deep, 700 mm above floor
Taps	Mixer tap, hot water should be thermostatically controlled, not exceed 43°C at the outlet Should be positioned on the nearest side to the WC pan
Hooks	Located at height of 1050 and 1400 mm
Alarm pull cord	With two red bangles of ø 50 mm One at 100 mm, the other at 800 - 1000 mm above floor level Should be operated from the WC and from the adjacent floor area
Toilet accessories	Automatic hand dryer, soap dispenser, alarm reset button, paper towel dispenser, toilet paper dispenser mounting height 800 - 1000 mm, suitable for single-hand use

# Functional Area WC

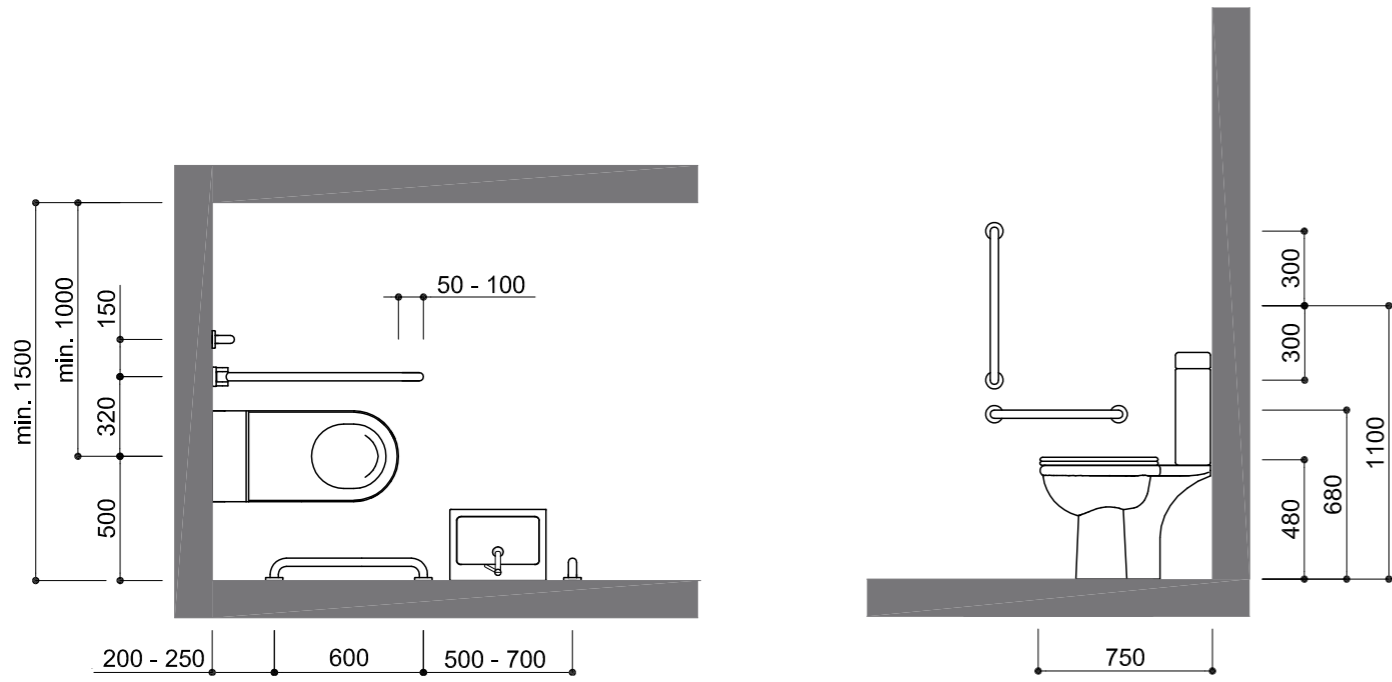

WC cubicle for wheelchair access

## INSTALLATION RECOMMENDATIONS

BS 8300:2009+A1:2010

Mounting-height	Top surface of WC seat 480 mm, WC pan can accept a variable height toilet seat riser
Depth of toilet	750 mm
Distance to wall	Centre of WC to wall 500 mm
Drop down support rail	Drop down support rail provided on the wall side at a distance of 320 mm from the centre line of WC Height 680 mm above floor Should extend 50 - 100 mm beyond the front of the WC Horizontal support rail on the wall adjacent to the WC 600 mm

# Functional Area WC

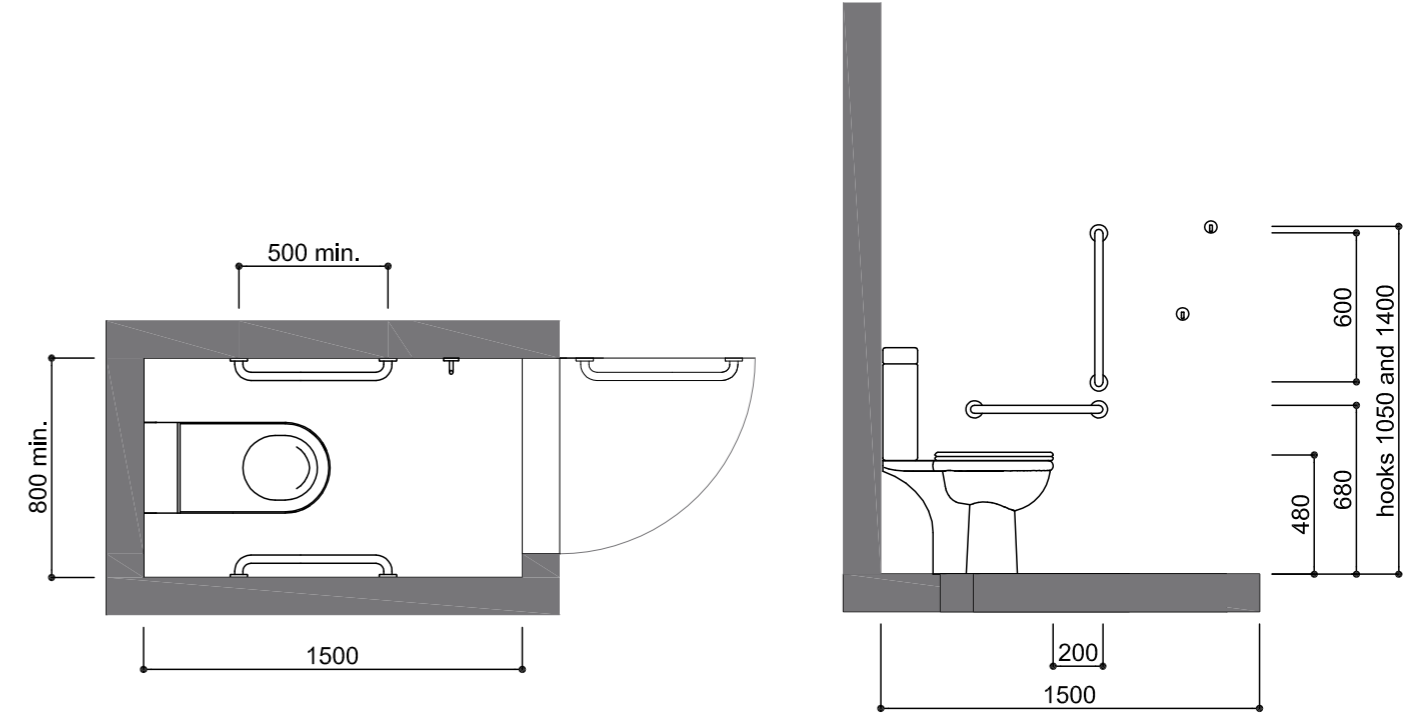

WC cubicle for ambulant disabled people

## INSTALLATION RECOMMENDATIONS

BS 8300:2009+A1:2010

Horizontal grab rail	Mounting height 680 mm above floor, length 600 mm Distance 200 - 250 mm from the back wall, clearance 50 - 60 mm between the rail and the wall
Vertical grab rail	Length 600 mm, 470 mm from the WC centre line Centre line 1100 mm above floor level
Toilet paper holder	Should be suitable for single hand use Should be readily accessible from a wheelchair, seated on the WC or for a standing person
Shelf	Where a high or low level cistern is used, a shelf 125 - 150 mm deep, preferably 400 mm wide should be provided preferably to the WC pan, top of surface 950 mm

# Functional Area Urinal

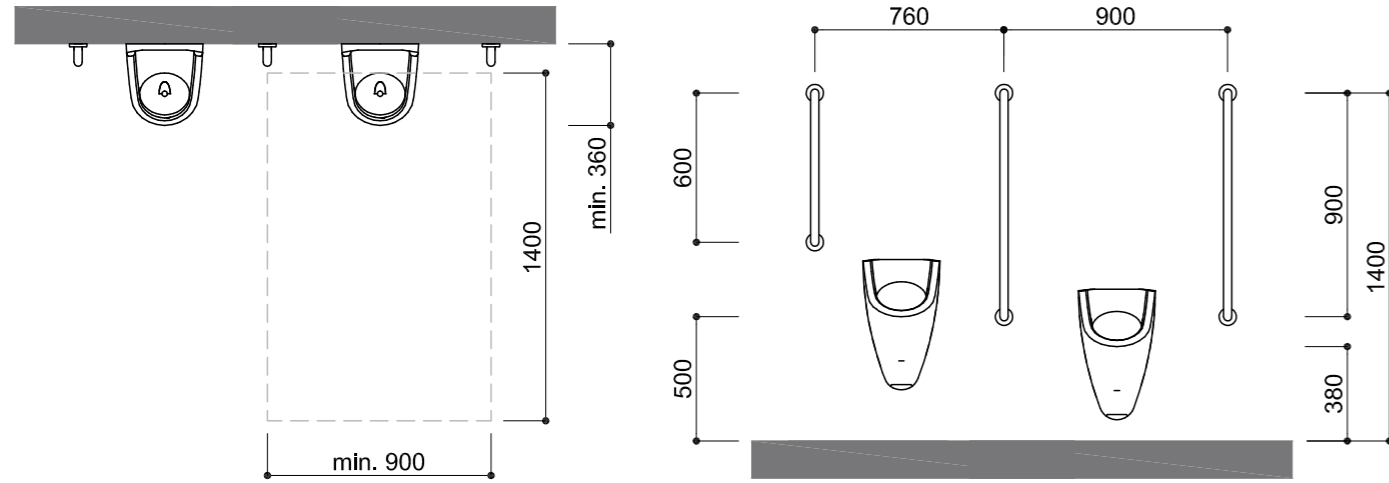

Urinal

## INSTALLATION RECOMMENDATIONS

BS 8300:2009+A1:2010

Access space	900 mm wide, 1400 mm depth wheelchair, access space
Rim height urinal	500 mm for standing users 380 mm for wheelchair users Urinal rim should project at least 360 mm from the wall face
Vertical grab rail	600 mm long for standing users 900 mm long for wheelchair users
Mounting height grab rail	Top fixing 1400 mm above floor
Distance grab rail	Distance grab rails 760 mm, standing users Distance grab rails 900 mm, wheelchair users
Contrast	Urinal should contrast visually with the wall it is attached to

# Functional Area Shower

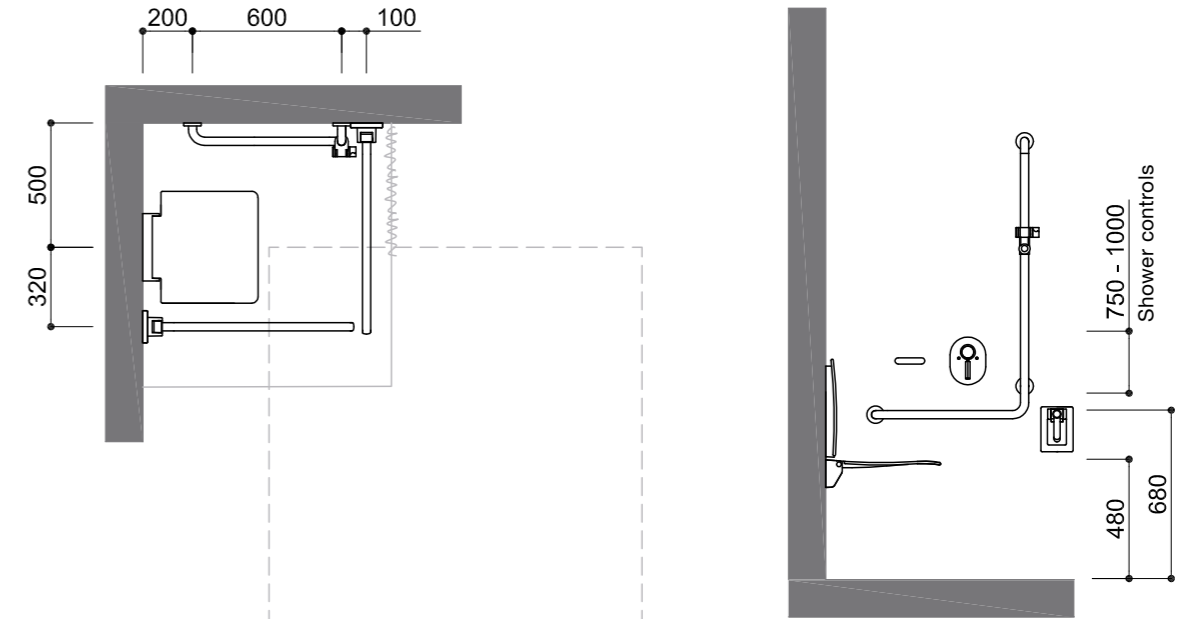

## INSTALLATION RECOMMENDATIONS

BS 8300:2009+A1:2010

Wheelchair turning space	1500 x 1500 mm
Floor surface	Should be slip-resistant
Tip-up shower seat	Seat height 480 mm, centre of seat to wall 500 mm Projection 650 mm, backrest at 200 mm distance from the back wall
Vertical grab rail	Height 800 mm above floor, length min. 600 mm
Horizontal grab rail	Length 600 mm, distance 200 mm from the back wall Height 680 mm above floor
Drop down support rail	Mounting height 680 mm above floor, on side and far wall Drop down support rail provided on the side wall at a distance of 320 mm from the centre line of the seat Drop down support rail provided on the far wall at a distance of 900 mm from the back wall
Shower head	Mounted on a vertical rod, adjustable between 1050 to 1850 mm Distance 500 mm to the back wall
Shower controls	Height range 750 to 1000 mm above the floor, water temperature not exceeding 43°C
Accessories	Soap tray, towel rail
Shower curtain	Operated from the shower seat, should enclose the seat and rails Dimension 1000 - 1200 mm
Hooks	Located at height of 1050 and 1400 mm

Use of the following HEWI services facilitates your daily work, from the planning & design, to the construction through to the fitout and use of a building

## ADVICE

- Comprehensive advice in all phases of the planning & design across the whole range of HEWI products and services
- Tender support
- Sampling
- Designing solutions to individual problems
- Assistance with making presentations to owners and investors
- Guidance from HEWI specialists for: accessibility, signage systems as well as personalised solutions for handrails
- Planning & design support for accessibility from the accessibility service centre
- Information on statutory provisions

## HEWI PLANNING SERVICE

HEWI offers an extensive, bespoke support service with its planning and specification service for architects, retailers, builders' merchants, building contractors and users. We use your measurement and your floorplan sketch showing the positions of the connections to draw up and individual and directly implementable fitout proposal (on request also available as a 3D presentation).

## TOOLS

- Product catalogue on the internet
- Technical information on the topic of accessible living
- Sample blocks and colour charts
- Product display systems

## SEMINARS

- CPD Presentations to architects, planners & designers, owners, investors, retail & wholesale trade, building contractors and users – for our current seminar programme, visit [www.hewi.com](http://www.hewi.com)
- Basic and advanced seminars on the topic of accessibility
- Specialist lectures and talks

## HEWI CATALOGUES

The HEWI complete catalogues give you an overview of sanitary and hardware products. They can be easily requested from: [www.hewi.com/brochures](http://www.hewi.com/brochures)

You will find in-depth information on our products on our website: [www.hewi.co.uk](http://www.hewi.co.uk)



Brochure Comfort to Care  
PR288GB

With the brochure „Comfort to Care“, HEWI presents a complex brochure which deals with the demographic change and the resulting challenges from it. By showing proven examples, the bathroom planning becomes more clear and visible. Professional articles from experts of architecture, economy and practical experience, inform about topics such as the consequences of the demographic change, kinaesthesia and Universal Design and therefore, deliver interesting background knowledge. By showing examples and a range of layouts, bathroom planning becomes clearer. 'Comfort to Care' allows you to imagine how HEWI products can adapt to each environment.



Catalogue Sanitary  
PUSAN12GB



Brochure Accessoires | Care  
PR291D/GB



Catalogue Hardware  
PUBB12GB



Brochure Hardware  
PR292D/GB

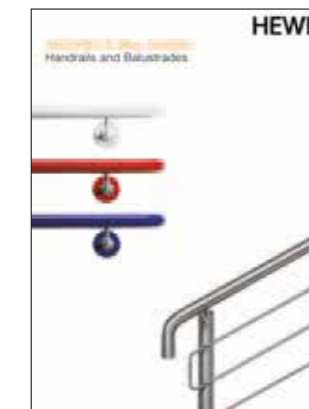

Brochure Handrails and Balustrades  
PR262GB

**NORWICH**

61-67 St. Benedicts Street,  
Norwich, NR2 4PD  
Tel: 01603 216500  
Fax: 01603 216510  
Email: [sales@acleigh.co.uk](mailto:sales@acleigh.co.uk)

**COLCHESTER**

11 Grange Way,  
Whitehall Industrial Estate,  
Colchester, CO2 8HG  
Tel: 01206 877488  
Fax: 01206 877480  
Email: [colchester@acleigh.co.uk](mailto:colchester@acleigh.co.uk)

**IPSWICH**

Unit 2-3, Dencora Business Centre,  
Whitehouse Road, Ipswich, IPI 5LT  
Tel: 01473 292810  
Fax: 01473 292818  
Email: [ipswich@acleigh.co.uk](mailto:ipswich@acleigh.co.uk)

[www.acleigh.co.uk](http://www.acleigh.co.uk)