

From the **Anvil**[®]



THE COLLECTION

ISSUE SEVEN

UPDATES &
NEW PRODUCTS



AC LEIGH

ARCHITECTURAL IRONMONGERS
SECURITY SPECIALISTS

Issue Seven - Updates & New Products

INTRODUCTION

Welcome to our latest 'From the Anvil' catalogue where we have combined over seventy brand new exclusive items and a range of new finishes for some of our existing products to offer you the complete ironmongery solution for your entire home.

A number of items have been introduced throughout the brochure and they have also been included in a section of completely new products at the back of this 'Issue Seven - Updates & New Products'

We have been designing and making our products in the traditional way using forged steel, combining strength with beauty for many years. Each piece is hand crafted giving you the opportunity to buy ironmongery that is individual rather than mass produced and giving a wider availability for all.

Issue Seven

CONTENTS

PRODUCT FINISHES - Page 4-5

HINGES - Page 6-15

THUMBLATCHES & LATCHES - Page 16-23

RING TURNS - Page 24-25

LEVER HANDLES - Page 26-38

PULL HANDLES - Page 39-45

RIM & MORTICE KNOBS - Page 46-49

RIM LOCKS & BOX LOCKS - Page 50-53

ESCUTCHEONS & THUMBTURNS - Page 54-56

DOOR KNOCKERS - Page 57-58

LETTERPLATES & COVERS - Page 59-61

DOOR GRILLS, NAILS & STUDS - Page 62-64

BOLTS - Page 65-69

HOOKS - Page 70-74

CUPBOARD KNOBS, LATCHES & TURNS - Page 75-80

WINDOW FASTENERS & ACCESSORIES - Page 81-85

WINDOW STAYS - Page 86-90

WINDOW ESPAGNOLETTES - Page 91-96

CURTAIN POLE FURNITURE - Page 97-99

LOCKS, LATCHES & ACCESSORIES - Page 100-104

ELECTRICAL ACCESSORIES - Page 105-106

NEW PRODUCTS - Page 107-114

GENERAL MAINTENANCE, CARE GUIDE & SPARES - Page 115

SUPPLY POLICY & CONDITIONS OF SALE - Page 116

INDEX - Page 117-119

Copyright - From The Anvil

FROM THE ANVIL THE COLLECTION - ISSUE SEVEN PRODUCT FINISHES

Finish symbols are displayed under each product to denote specific finishes available for each piece.



BEESWAX

Beeswax Finish - (For Internal Use Only)

The beeswax finish is the most authentic finish for steel. When our highly skilled blacksmiths have finished forging this product the colours left in the steel range from blue to deep red ochre. To preserve these beautiful colours and the texture from the hammer and anvil, we apply pure beeswax. This gives a subtle, matt richness to the metal and offers excellent protection when products are fitted internally and properly maintained. To bring out the best in our original Beeswax Finish we advise that before installation it is given a buff with a soft cloth.

Using maintenance wax will help restore the finish and give protection to this product. Buffing with a cotton cloth will remove the white bloom. If surface rust occurs, rub with 00 grade wire wool and apply Anvil Maintenance Wax with a rag. All moving parts should be oiled prior to fitting and periodically afterwards.

Warning: The chemicals in wet plaster will rust this product. Always fit ironmongery when plaster is fully dry.



BLACK

Black Finish - (For Internal or External Use)

Our traditional satin Black Finish is baked in a high-temperature oven giving it an attractive, durable and corrosion-resistant finish which is low maintenance and can be used internally or externally. It is resistant to moisture so can be used in bathrooms and damp conditions.

We recommend that the ironmongery is wiped with a lightly oiled cloth from time-to-time. This will remove harmful deposits and restore it to its original condition. All moving parts should be oiled prior to fitting and periodically afterwards.

Always use a pilot drill and rub screw with candle wax before fitting.



PEWTER
PATINA

Pewter Patina Finish - (For Internal or External Use)

This finish is elegant and beautifully highlights the texture of the steel. Stylish and modern, it is equally suited to a contemporary home as well as a period property.

It has excellent anti-corrosion properties and we recommend that the ironmongery is wiped with a lightly oiled cloth once a month. This will remove harmful deposits and restore it to its original condition. Never use any form of metal cleaner or aerosol spray. All moving parts should be oiled prior to fitting and periodically afterwards.

The screws supplied with this product are finished individually so please take care when fitting. Always use a pilot drill and rub screw with candle wax before fitting.



BRONZE

Bronze Finish - (For Internal or External Use)

This range is coated with a permanent bronze finish which will always look at its best for years to come and is completely weatherproof. This finish is elegant and beautifully highlights the texture of the steel. Stylish and modern, it is equally suited to a contemporary home as well as a period property.

It has excellent anti-corrosion properties and we recommend that the ironmongery is wiped with a lightly oiled cloth once a month. This will remove harmful deposits and restore it to its original condition. Never use any form of metal cleaner or aerosol spray. All moving parts should be oiled prior to fitting and periodically afterwards.

The screws supplied with this product are finished individually so please take care when fitting. Always use a pilot drill and rub screw with candle wax before fitting.



ANTIQUÉ
BRASS

Antique Brass Finish - (For Internal or External Use)

All of our Antique Brass products are cast from high quality solid brass and have been manufactured to the highest standards. This finish has been treated to speed up the natural tarnishing process which produces the antique feel of the product. It is burnished making it smooth in appearance and is used as an alternative finish where a highly polished surface is not desired.

The finish is un-lacquered, will tarnish naturally and therefore the aged patina will become darker with time. If you require a semi gloss finish, it can be achieved by using Brasso.

Always use a pilot drill and rub screw with candle wax before fitting.

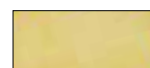

POLISHED
BRASS

Polished Brass Finish - (For Internal or External Use)

All of our Polished Brass products are manufactured to the highest standards. All products are un-lacquered so to retain the original finish, regular polishing with a good quality metal polish is essential. However, if the intention is to allow the surface to age through oxidization, no attention needs to be given. Over time the brass will acquire a darker and more aged patina.

Always use a pilot drill and rub screw with candle wax before fitting.

Warning: The chemicals in wet plaster will rust this product. Always fit ironmongery when plaster is fully dry.

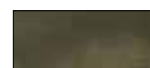

IRON

Iron Finish - (For Internal or External Use)

This product is made from Iron which shows off the natural beauty and texture of the metal. The item is cast and dressed giving it a tactile finish. This product will show off the natural beauty and texture of the metal. It is protected from weather and high moisture areas by a clear powder coating process which also gives it its colour. This finish provides an attractive, durable and corrosion resistant coating which will last for many years.

Always use a pilot drill and rub screw with candle wax before fitting.

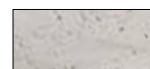

NATURAL
SMOOTH

Natural Smooth Finish - (For Internal Use Only)

A natural cast iron, finished with a clear matt lacquer which produces a beautifully textured look and feel. This product is only intended for internal use. If fitted externally i.e in an enclosed porch or bathroom it will need to be treated with Anvil Maintenance Wax periodically.

Always use a pilot drill and rub screw with candle wax before fitting.

Warning: The chemicals in wet plaster will rust this product. Always fit ironmongery when plaster is fully dry.



NATURAL
TEXTURED

Natural Textured Finish - (For Internal Use Only)

A natural cast iron, finished with a clear matt lacquer which produces a beautifully textured look and feel. These products are only intended for internal use or when used in a protected area like in an enclosed porch but need to be waxed periodically.



ANTIQUÉ
PEWTER

Antique Pewter Finish - (For Internal or External Use)

This Antique Pewter finish is applied to the product and has excellent anti-corrosion properties. Periodic wiping with a lightly oiled cloth will further help to preserve the beauty of this finish.



POLISHED
CHROME

Polished Chrome Finish - (For Internal or External Use)

A mirror finished, chrome plate applied to either solid brass or steel.



BRUSHED
SATIN CHROME

Brushed Satin Chrome Finish - (For Internal or External Use)

A satin chrome finish which has a brushed effect running down the product..



POLISHED
NICKEL

Polished Nickel Finish - (For Internal or External Use)

A highly polished finish with a nickel plating applied to a solid brass substrate. Nickel is similar to the polished chrome (silver) finish but with a slightly warmer tone. An unlaquered finish because nickel will not tarnish.

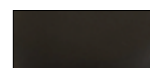

EBONY

Ebony - (For Internal or External Use)

Our Ebony finish products have a rich, dark look and feel for a very distinctive quality. The material has a very high density and fine texture which gives a very smooth finish. Can be polished or waxed to maintain the vibrance of the wood and to give overall protection. Designed to be used internally but can also be used externally if maintained with Anvil wax.



ROSEWOOD

Rosewood - (For Internal or External Use)

Our Rosewood products are strong and heavy with a richly hued reddish colour and much darker veining. Can be polished or waxed to maintain the vibrance of the wood and to give overall protection. Designed to be used internally but can also be used externally if maintained with Anvil wax.

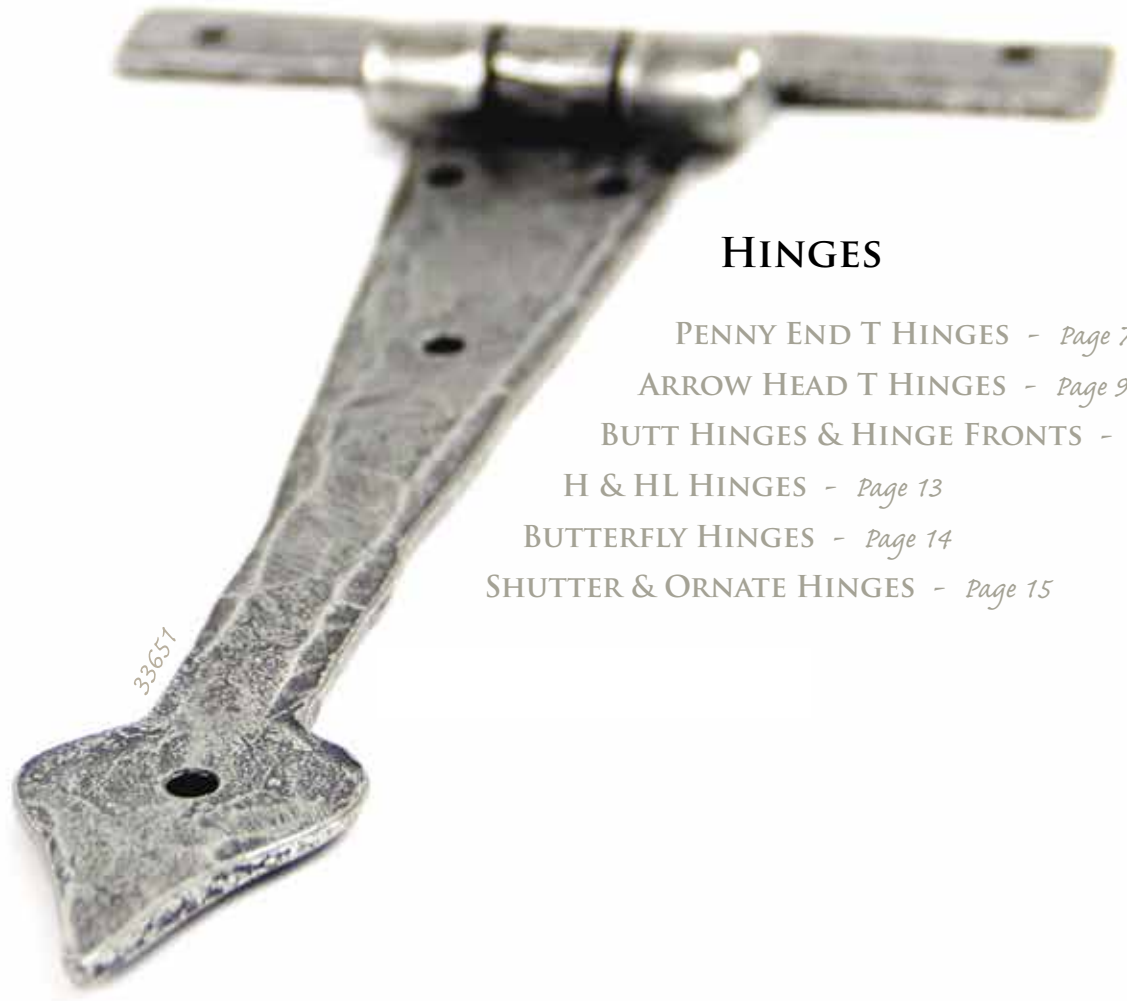

HINGES

- PENNY END T HINGES - Page 7-8
- ARROW HEAD T HINGES - Page 9-11
- BUTT HINGES & HINGE FRONTS - Page 12
- H & HL HINGES - Page 13
- BUTTERFLY HINGES - Page 14
- SHUTTER & ORNATE HINGES - Page 15



33010 (18" T Hinge)

22" T HINGE

OVERALL SIZE: 560MM X 152MM
 FIXING PLATE: 152MM X 38MM
 HINGE ARM: 508MM



-  **33011**
BEESWAX
-  **33012**
BLACK
-  **33655**
PEWTER PATINA

Made from thicker steel and is ideal for carrying very heavy, 3' doors or bigger.

18" T HINGE

OVERALL SIZE: 457MM X 127MM
 FIXING PLATE: 127MM X 25MM
 HINGE ARM: 407MM



33656 - Pewter Patina Finish

Suitable for 2'6" to 2'9" ledged doors.

-  **33010**
BEESWAX
-  **33009**
BLACK
-  **33656**
PEWTER PATINA

15" T HINGE

OVERALL SIZE: 381MM X 127MM
FIXING PLATE: 127MM X 25MM
HINGE ARM: 330MM



33184 - Beeswax Finish



Suitable for 2' to 2'3" doors.

33184 BEESWAX **33990** BLACK **33653** PEWTER PATINA

12" T HINGE

OVERALL SIZE: 305MM X 115MM
FIXING PLATE: 115MM X 25MM
HINGE ARM: 254MM



33652 - Pewter Patina Finish

Suitable for wardrobe doors.



33006 BEESWAX **33989** BLACK **33652** PEWTER PATINA

9" T HINGE

OVERALL SIZE: 228MM X 102MM
FIXING PLATE: 102MM X 25MM
HINGE ARM: 178MM



33988 - Black Finish

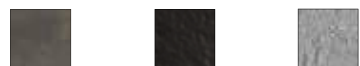

Suitable for wide kitchen cupboard doors.

33204 BEESWAX **33988** BLACK **33789** PEWTER PATINA

6" T HINGE

OVERALL SIZE: 152MM X 102MM
FIXING PLATE: 102MM X 13MM
HINGE ARM: 114MM



33154 - Beeswax Finish

Suitable for hand crafted cupboard doors.

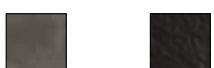

33154 BEESWAX **33987** BLACK

4" T HINGE

OVERALL SIZE: 102MM X 79MM
FIXING PLATE: 79MM X 13MM
HINGE ARM: 76MM



33650 - Pewter Patina Finish



33188 BEESWAX **33986** BLACK **33650** PEWTER PATINA



ARROW HEAD T HINGES

33654 (18" T Hinge) & 33638 (Gothic Thumbatch)

35" HOOK & BAND HINGE - CRANKED

OVERALL SIZE: 889MM X 194MM
FIXING PLATE: 194MM X 54MM (PIN DIAMETER: 15MM)
HINGE ARM: 825MM



33234 - Black Finish



Ideal for barn or garage doors. This hinge is cranked to allow the door to be in line with the front of the frame. There is no need for the fixing plate to be morticed into the frame of the door.

33234 BLACK

24" HOOK & BAND HINGE

OVERALL SIZE: 610MM X 158MM
FIXING PLATE: 158MM X 51MM (PIN DIAMETER: 15MM)
HINGE ARM: 577MM



33189 - Beeswax Finish

Ideal for heavy, internal doors. The hook plate needs to be morticed into the frame, making the door in-line with the frame.



33189 BEESWAX **33286** BLACK

24" BAND & SPIKE HINGE

OVERALL SIZE: 610MM X 190MM
 SPIKE: 158MM OVERALL: 190MM (PIN DIAMETER: 15MM)
 HINGE ARM: 572MM



■ Ideal for heavy, internal doors. When fixing the Spike Pin you need to drill a series of pilot holes.

33216
BEESWAX

6" T HINGE

OVERALL SIZE: 178MM X 102MM
 FIXING PLATE: 102MM X 13MM
 HINGE ARM: 157MM

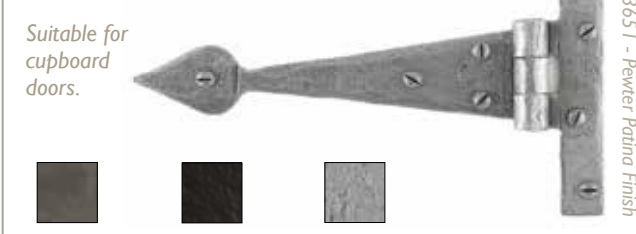

Suitable for cupboard doors.

■ ■ ■
33207 **33972** **33651**
 BEESWAX BLACK PEWTER PATINA

4" T HINGE

OVERALL SIZE: 114MM X 83MM
 FIXING PLATE: 83MM X 16MM
 HINGE ARM: 88MM



Ideal for hand crafted kitchen cupboard doors.

■ ■ ■
33208 **33971** **33774**
 BEESWAX BLACK PEWTER PATINA

36" BARN DOOR T HINGE

OVERALL SIZE: 914MM X 305MM
 FIXING PLATE: 305MM X 51MM
 HINGE ARM: 838MM



This hinge can carry the largest of barn or garage doors and allows the door to be in line with the front of the frame.

33233
BLACK

18" SMOOTH T HINGE

OVERALL SIZE: 467MM X 102MM
 FIXING PLATE: 102MM X 25MM
 HINGE ARM: 425MM



A high quality cast smooth T hinge suitable for use on a variety of ledged and braced doors up to 2'9" wide.

73228
BLACK

18" T HINGE

OVERALL SIZE: 457MM X 127MM
 FIXING PLATE: 127MM X 25MM
 HINGE ARM: 425MM

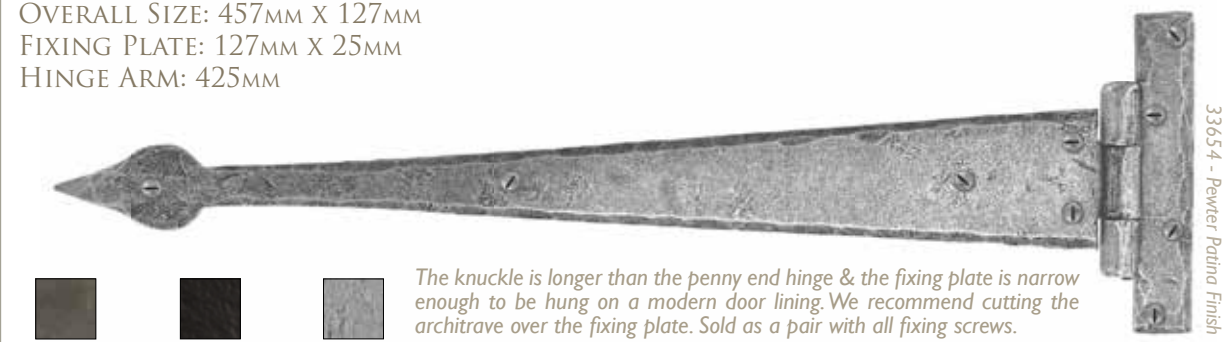

The knuckle is longer than the penny end hinge & the fixing plate is narrow enough to be hung on a modern door lining. We recommend cutting the architrave over the fixing plate. Sold as a pair with all fixing screws.

■ ■ ■
33158 **33974** **33654**
 BEESWAX BLACK PEWTER PATINA

16" SMOOTH T HINGE

OVERALL SIZE: 394MM X 102MM
 FIXING PLATE: 102MM X 25MM
 HINGE ARM: 356MM



A high quality cast smooth T hinge suitable for use on a variety of smaller door sizes (2' to 2'3").

73227
BLACK

12" T HINGE

OVERALL SIZE: 305MM X 121MM
 FIXING PLATE: 121MM X 19MM
 HINGE ARM: 267MM



This hinge is ideal for small wardrobe doors.

■ ■ ■
33206 **33973** **33657**
 BEESWAX BLACK PEWTER PATINA

12" SMOOTH T HINGE

OVERALL SIZE: 318MM X 102MM
 FIXING PLATE: 102MM X 25MM
 HINGE ARM: 273MM



A high quality cast smooth T hinge suitable for use on a variety of cupboard & wardrobe doors.

73226
BLACK



HINGE FRONTS & BUTT HINGES

16633/2 (4" Ball Bearing Butt Hinge) & 33238 (18" Hinge Front)

3" BUTT HINGE

HINGE SIZE: 77MM X 51MM (Beeswax/Pewter)
 LEAF WIDTH: 19MM (Beeswax/Pewter)
 HINGE SIZE: 77MM X 63MM (Black)
 LEAF WIDTH: 26MM (Black)
 Comes in three finishes matching our door or cabinet furniture. Typical used for ledged and braced doors. Sold in pairs with all fixing screws.

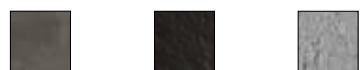

33436 **16632/1** **33692**
 BEESWAX BLACK PEWTER PATINA



33436 - Beeswax Finish

4" BUTT HINGE

HINGE SIZE: 102MM X 60MM (Beeswax/Pewter)
 LEAF WIDTH: 25MM (Beeswax/Pewter)
 HINGE SIZE: 102MM X 75MM (Black)
 LEAF WIDTH: 31MM (Black)
 Ideal for use with Hinge Fronts (see picture). Three finishes to match our door furniture. Sold in pairs with all fixing screws.

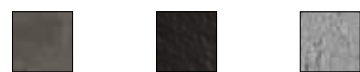

33437 **16633** **33693**
 BEESWAX BLACK PEWTER PATINA



33693 - Pewter Patina Finish

4" BALL BEARING BUTT HINGE

OVERALL SIZE: 102MM X 76MM
 LEAF WIDTH: 30MM

A heavy duty butt hinge, ideal for heavyweight doors. The smooth action of the ball bearing will last for years. Grade 13 Stainless Steel and CE marked. Ideal for use with Hinge Fronts (see picture) or to complete your door furniture. Sold in pairs with all fixing screws.



16633/2 **16614/1**
 BLACK SATIN STAINLESS STEEL



16633/2 - Black Finish

3" BALL BEARING BUTT HINGE

OVERALL SIZE: 76MM X 50MM
 LEAF WIDTH: 20MM
 A heavy duty butt hinge, ideal for heavyweight doors. The smooth action of the ball bearing will last for years. Sold in pairs with all fixing screws.



16632/2 **16612/A**
 BLACK SATIN STAINLESS STEEL



16632/2 - Black Finish

24" HINGE FRONT

OVERALL SIZE: 610MM X 57MM



33787 - Pewter Patina Finish



33241 **33239** **33787**
 BEESWAX BLACK PEWTER PATINA

This product is purely decorative when used in conjunction with matching butt hinges.

18" HINGE FRONT

OVERALL SIZE: 457MM X 51MM



33238 - Black Finish

This product is purely decorative when used in conjunction with matching butt hinges.



33240 **33238** **33786**
 BEESWAX BLACK PEWTER PATINA

7" H HINGE

OVERALL SIZE: 178MM X 70MM
 FIXING PLATE: 178MM X 25MM

Ideal for internal doors & shutters. This hinge may also be used in a bi-folding situation.



33181 **33785**
 BEESWAX PEWTER PATINA



33181 - Beeswax Finish

4" H HINGE

OVERALL SIZE: 102MM X 41MM
 FIXING PLATE: 102MM X 16MM

Ideal for use when hanging cabinet and cupboard doors or can be used with window shutters.



33628
 PEWTER PATINA



33628 - Pewter Patina Finish

3 1/4" H HINGE

OVERALL SIZE: 82MM X 32MM
 FIXING PLATE: 82MM X 13MM

Ideal for use when hanging cabinet and cupboard doors or can be used with window shutters.



33260 **33985** **33914**
 BEESWAX BLACK BRONZE



33914 - Bronze Finish

9" HL HINGE

OVERALL SIZE: 228MM X 235MM
 'L' FIXING PLATE: 228MM X 184MM

Used in similar applications to the H hinges but with one strap shaped like a letter L to provide extra strength for heavier or damaged doors.



33183 **33759**
 BEESWAX PEWTER PATINA



33183 - Beeswax Finish

7" HL HINGE

OVERALL SIZE: 178MM X 172MM
 'L' FIXING PLATE: 178MM X 133MM

Used in similar applications to the H hinges but with one strap shaped like a letter L to provide extra strength for heavier or damaged doors.



33182 **33760**
 BEESWAX PEWTER PATINA



33182 - Beeswax Finish

3 1/4" HL HINGE

OVERALL SIZE: 83MM X 70MM
 'L' FIXING PLATE: 83MM X 51MM

Used in similar applications to the H hinges but with one strap shaped like a letter L to provide extra strength for heavier or damaged doors.



33257 **33784**
 BEESWAX PEWTER PATINA



33257 - Beeswax Finish

H & HL HINGES

33257 (HL Hinge)

BUTTERFLY & HALF BUTTERFLY HINGES



33687 (Butterfly Hinge)

33783 - Pewter Patina Finish



HALF BUTTERFLY HINGE - LARGE

OVERALL SIZE: 82MM X 82MM
FIXING PLATE: 76MM X 16MM
HINGE ARM: 82MM X 57MM

A decorative hinge but with only one wing so they are easier to mount in restricted spaces. Sold as a pair with matching fixing screws.



33259 **33783**
BEESWAX PEWTER PATINA

33258 - Beeswax Finish



HALF BUTTERFLY HINGE - SMALL

OVERALL SIZE: 51MM X 51MM
FIXING PLATE: 51MM X 10MM
HINGE ARM: 51MM X 32MM

A decorative hinge but with only one wing so they are easier to mount in restricted spaces. Sold as a pair with matching fixing screws.



33258 **33782**
BEESWAX PEWTER PATINA

BUTTERFLY HINGE - LARGE

OVERALL SIZE: 127MM X 83MM
HINGE ARM: 83MM X 57MM

A decorative carpentry hinge that can be used for a number of larger applications like doors and desk lids. Sold as a pair with beeswaxed fixing screws.



33200 **33761**
BEESWAX PEWTER PATINA



33200 - Beeswax Finish

BUTTERFLY HINGE - SMALL

OVERALL SIZE: 76MM X 51MM
HINGE ARM: 51MM X 35MM

A decorative carpentry hinge that can be used for a number of smaller applications like kitchen cupboards and trinket boxes. Sold as a pair with matching fixing screws.



33199 **33687**
BEESWAX PEWTER PATINA



33687 - Pewter Patina Finish

ORNATE & SHUTTER HINGES



33213 (Shutter Hinge)

33213 - Beeswax Finish



SHUTTER HINGE

OVERALL HEIGHT: 102MM
HINGE LEAF: 38MM X 41MM
TAIL: 44MM X 51MM

French shutter hinges are designed with an angled offset on which the shutter is mounted so that when the shutter is opened it is thrown clear of the window. Sold as a pair with all fixing screws.



33213
BEESWAX

ORNATE HINGE

OVERALL SIZE: 95MM X 63MM
HINGE LEAVES: 60MM & 25MM

Sold as a pair with beeswaxed fixing screws.



33219
BEESWAX



33219 - Beeswax Finish

THUMBLATCHES & LATCHES

- BEAN THUMBLATCH - Page 17-18
- GOTHIC THUMBLATCH - Page 19
- THUMBLATCH ACCESSORIES - Page 20
- COTTAGE LATCH - Page 21
- PRIVACY LATCH - Page 22
- LATCH SET - Page 22
- SHAKESPEARE LATCH - Page 23



33100



BEAN THUMBLATCHES

33101 (Medium Bean Thumblatch)

MEDIUM BEAN THUMBLATCH

HANDLE LENGTH: 210MM
 THUMB BAR LENGTH: 140MM
 LATCH LENGTH: 190MM

The thumb piece passes through the door and raises the latch bar off the keep. To restrict the latch bar movement a staple pin and a screw on staple pin are provided (discard unused pin). For use on doors with a max thickness of 55mm.

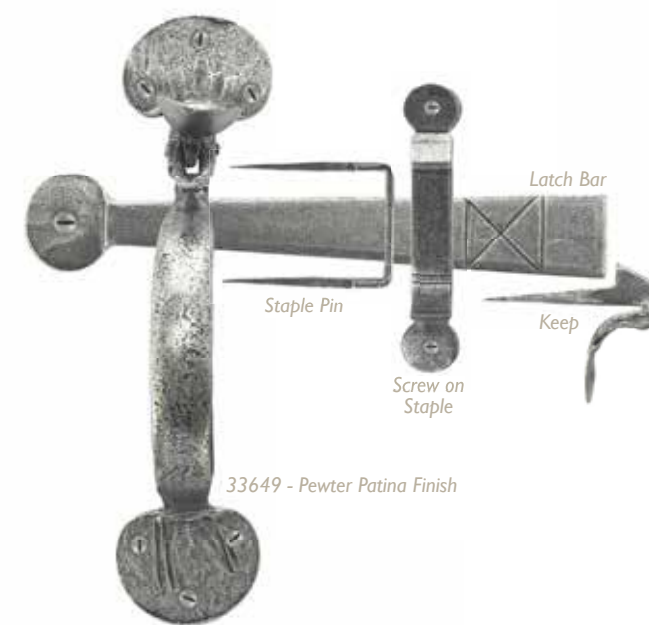

- 33101**
BEESWAX
- 33176**
BLACK
- 33649**
PEWTER PATINA

MEDIUM BEAN THUMBLATCH - XL

HANDLE LENGTH: 216MM
 THUMB BAR LENGTH: 165MM
 LATCH LENGTH: 190MM

The thumb piece passes through the door and raises the latch bar off the keep. To restrict the latch bar movement a staple pin and a screw on staple pin are provided (discard unused pin). Comes with an extra long thumb bar for use on doors with a maximum thickness of 75mm.



33101XL **33762**
 BEESWAX PEWTER PATINA

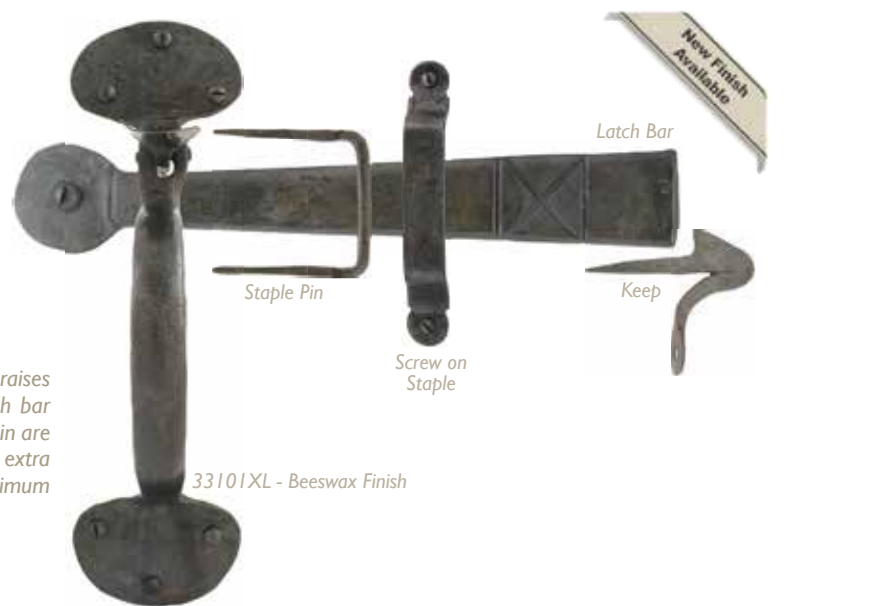

33101XL - Beeswax Finish

HEAVY BEAN THUMBLATCH

HANDLE LENGTH: 228MM
 THUMB BAR LENGTH: 140MM
 LATCH LENGTH: 216MM

The thumb piece passes through the door and raises the latch bar off the keep. To restrict the latch bar movement a screw on staple pin is provided. For use on doors with a max thickness of 55mm. This product has bigger proportions than the medium thumblatch and is designed for use on larger doors.



33159 **33253** **33763**
 BEESWAX BLACK PEWTER PATINA

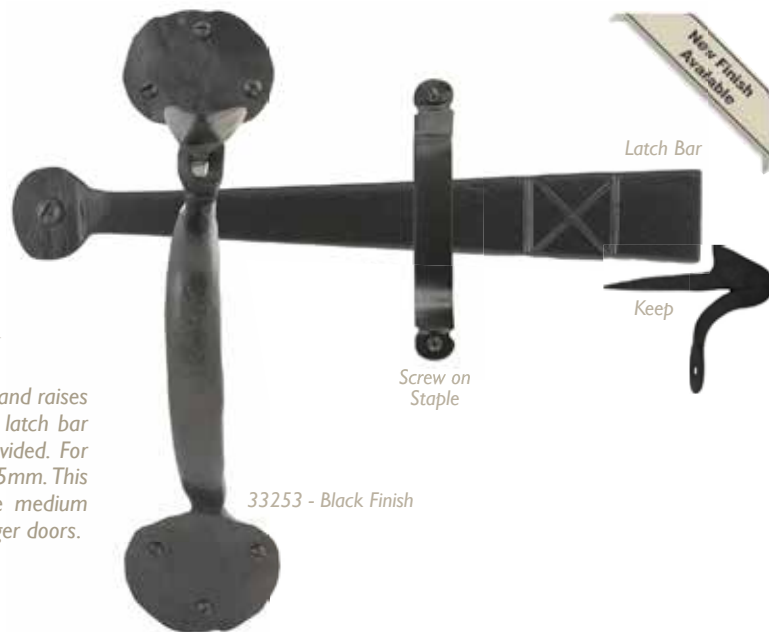

33253 - Black Finish

SLIM THUMBLATCH

HANDLE LENGTH: 222MM
 THUMB BAR LENGTH: 127MM
 LATCH LENGTH: 184MM

A different style of thumblatch (see picture - page 16) to the others in our collection with a slim profile handle and a much chunkier look and feel to it. The thumb piece passes through the door and raises the latch bar off the keep. To restrict the latch bar movement a screw on staple pin is provided. For use on doors with a max thickness of 45mm.



33100
 BEESWAX

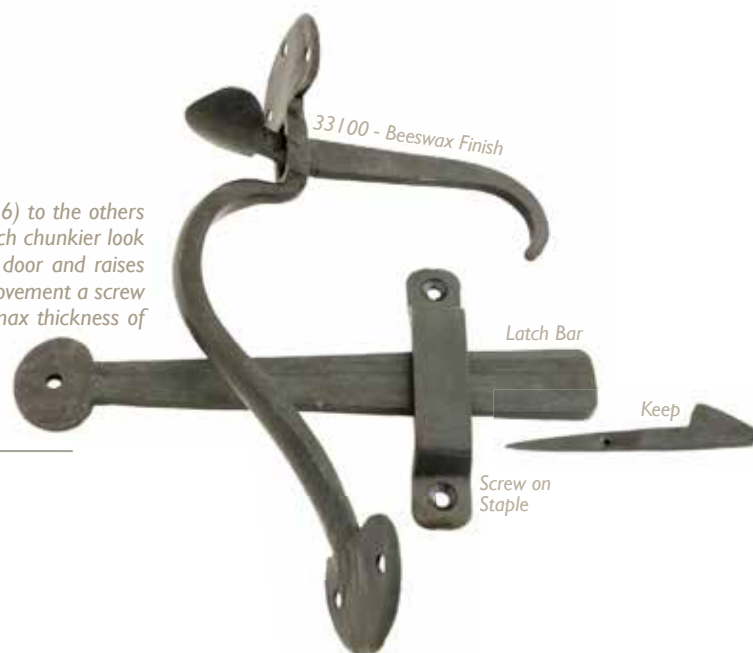

33100 - Beeswax Finish



33638 (Gothic Thumblatch)



GOTHIC THUMBLATCHES

GOTHIC THUMBLATCH

HANDLE LENGTH: 216MM
 THUMB BAR LENGTH: 140MM
 LATCH LENGTH: 190MM

The thumb piece passes through the door and raises the latch bar off the keep. To restrict the latch bar movement a staple pin and a screw on staple pin are provided (discard unused pin). For use on doors with a max thickness of 55mm.



33150 **33970** **33638**
 BEESWAX BLACK PEWTER PATINA

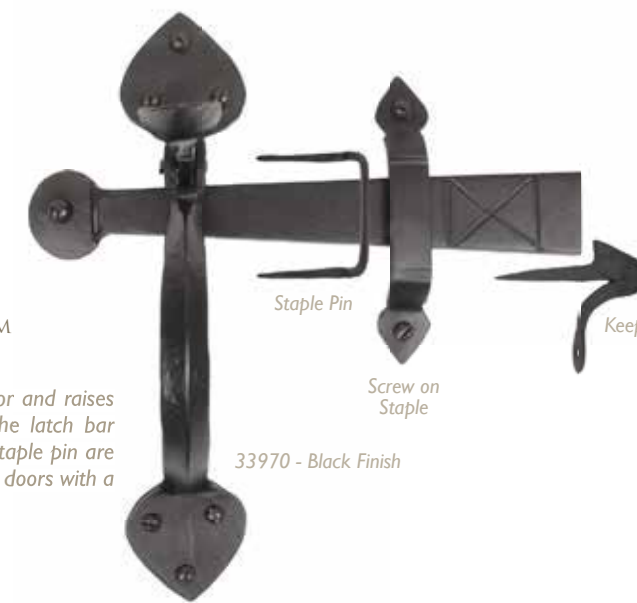

33970 - Black Finish

GOTHIC THUMBLATCH - XL

HANDLE LENGTH: 216MM
 THUMB BAR LENGTH: 165MM
 LATCH LENGTH: 190MM

The thumb piece passes through the door and raises the latch bar off the keep. To restrict the latch bar movement a staple pin and a screw on staple pin are provided (discard unused pin). Comes with an extra long thumb bar for use on doors with a maximum thickness of 75mm.



33150XL
 BEESWAX

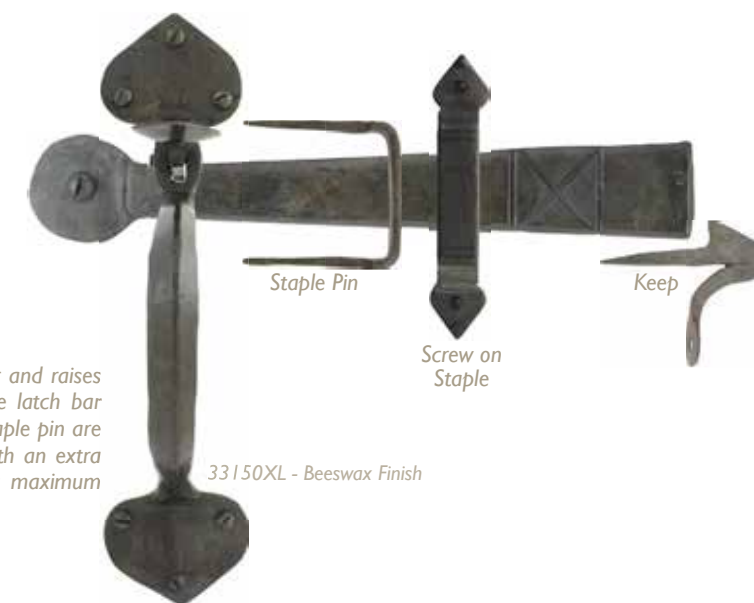

33150XL - Beeswax Finish

THUMBLATCH ACCESSORIES



33637 (Screw on Staple - Gothic End)

SCREW ON STAPLE GOTHIC END

OVERALL SIZE: 102MM X 14MM

Can be used as a replacement for a missing part from an existing thumb latch set. Ideal to use instead of the 'drive-in' staple pin if fitting on a thinner door.



33304/1 BEESWAX **33817** BLACK **33637** PEWTER PATINA



SCREW ON STAPLE PENNY END

OVERALL SIZE: 120MM X 16MM

Can be used as a replacement for a missing part from an existing thumb latch set. Ideal to use instead of the 'drive-in' staple pin if fitting on a thinner door.



33304 BEESWAX **33175** BLACK **33639** PEWTER PATINA



33304 - Beeswax Finish

STAPLE PIN

OVERALL SIZE: 54MM X 63MM

A replacement staple pin in case of a missing part from an existing set.



33202 BEESWAX **33968** BLACK **33780** PEWTER PATINA

33202 - Beeswax Finish

LOCKING STAPLE PIN

OVERALL SIZE: 54MM X 63MM

Can be used to lock your bathroom or toilet. Supplied with a leather thong & pin to stop the movement of the latch bar.



33244 BEESWAX **33174** BLACK **33648** PEWTER PATINA

33174 - Black Finish

FRAME KEEP PIN

OVERALL SIZE: 63MM X 54MM

A replacement frame keep in case of a missing part from an existing set.

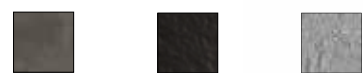

33203 BEESWAX **33969** BLACK **33781** PEWTER PATINA

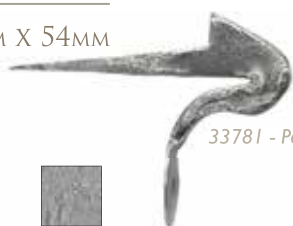

33781 - Pewter Patina Finish

LATCHES & RING TURNS



33295 (Cottage Latch - Right Hand)

COTTAGE LATCH LEFT HAND

OVERALL SIZE: 152MM X 101MM
HANDLE SIZE: 69MM
ROSETTE SIZE: 67MM

The Cottage Latch is supplied with all fixing screws and an 8mm spindle. It also comes with matching ring for the other side of the door with a rosette back plate.

Made from steel including the bar and keeps, which makes it the only one in the country to be made like this i.e steel throughout.



33147L BEESWAX **33294** BLACK **33666** PEWTER PATINA



33147L - Beeswax Finish

COTTAGE LATCH RIGHT HAND

OVERALL SIZE: 152MM X 101MM
HANDLE SIZE: 69MM
ROSETTE SIZE: 67MM

The Cottage Latch is supplied with all fixing screws and an 8mm spindle. It also comes with matching ring for the other side of the door with a rosette back plate.

Made from steel including the bar and keeps, which makes it the only one in the country to be made like this i.e steel throughout.



33147R BEESWAX **33295** BLACK **33667** PEWTER PATINA

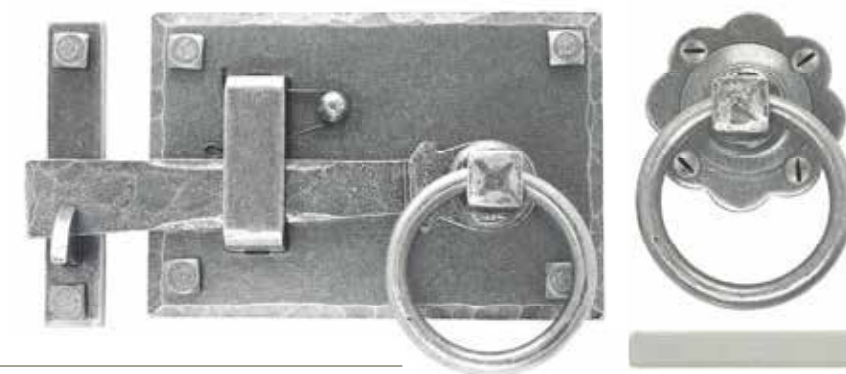

33667 - Pewter Patina Finish



PRIVACY & LATCH SET

33966 (Latch Set)



SHAKESPEARE LATCH

33685 (Shakespeare Latch Set)

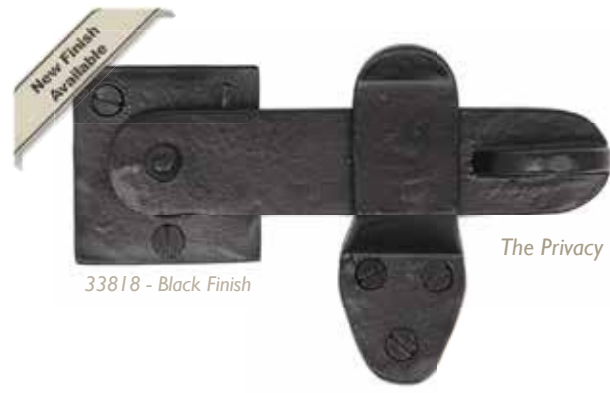

PRIVACY LATCH SET

OVERALL SIZE: 146MM X 28MM
LATCH LENGTH: 133MM
FIXING PLATE: 51MM X 51MM

The Privacy Latch Set cannot be opened from the outside. Supplied with all fixing screws.

-  **33296**
BEESWAX
-  **33818**
BLACK

LATCH SET

OVERALL SIZE: 165MM X 25MM
STAPLE SIZE: 54MM X 63MM
SCREW ON STAPLE SIZE: 120MM X 16MM

The Latch Set is mainly used on doors with single-side access (airing cupboards etc.) and is opened by a knob on the latch bar. To restrict the latch bar movement a staple pin and a screw on staple pin are provided (discard unused pin).

-  **33160**
BEESWAX
-  **33966**
BLACK
-  **33779**
PEWTER PATINA



SHAKESPEARE LATCH SET

HANDLE WIDTH: 95MM
LATCH LENGTH: 178MM
FIXING PLATE: 127MM
KEEP SIZE: 127MM X 27MM

The Shakespeare Range has been hand-crafted and is truly an elegant work of art. This set comes complete with two handles and an 8mm spindle long enough for a 3" door or gate thickness.

-  **33685**
PEWTER PATINA



RING TURNS

33686 (Shakespeare Ring Turn)

RING TURNS

SHAKESPEARE RING TURN SET - Page 25

RING TURN HANDLE SET - Page 25



33689

SHAKESPEARE RING TURN SET

HANDLE WIDTH: 95MM
FIXING PLATE: 127MM

A ring turn set based on the elegant Shakespeare latch. Comes complete with two handles, an 8mm spindle (long enough for a 3' door or gate) and a 4" heavy duty latch (18299/4") (see page 102) which is designed for large doors with a wide stile or centre middle rail.



33686 PEWTER PATINA



33951 BRONZE



33951 - Bronze Finish

RING TURN HANDLE SET

HANDLE SIZE: 67MM
ROSETTE SIZE: 67MM
SPINDLE SIZE: 8MM

A traditional looking ring turn set which is ideal for many doors around the home. Comes complete with two ring handles, an 8mm spindle and all matching fixing screws. See page 102 for suitable latches.

33017 - Black Finish



33112 BEESWAX



33017 BLACK



33689 PEWTER PATINA

LEVER HANDLES

- CURLY LEVER HANDLES - Page 27
- MONKEYTAIL LEVER HANDLES - Page 28
- COTTAGE LEVER HANDLES - Page 29
- OAK LEVER HANDLES - Page 30
- SMOOTH LEVER HANDLES - Page 30
- STRAIGHT LEVER HANDLES - Page 31
- NARROW LEVER HANDLES - Page 32
- AVON LEVER HANDLES - Page 32-33
- GOthic LEVER HANDLES - Page 34-35
- GOthic CURVED LEVER HANDLES - Page 36
- TUDOR LEVER HANDLES - Page 37
- CROMWELL LEVER HANDLES - Page 38



33123

83500 - Natural textured Finish



CURLY LEVER LOCK SET

BACKPLATE SIZE: 165MM X 51MM
HANDLE LENGTH: 114MM
CENTRES: 57MM

A very traditional style curly sprung lever handle which is a faithful reproduction of a classic design. Finished off with the superb Natural Textured finish to give the old design a brand new lease of life and much more of a contemporary look and feel. Only for use internally or where protected. See page 101 for suitable locks.

83500
NATURAL
TEXTURED



CURLY LEVER HANDLES

83500 (Curly Lever Lock)



83501 - Natural textured Finish

CURLY LEVER LATCH SET

BACKPLATE SIZE: 165MM X 51MM
HANDLE LENGTH: 114MM

A handle to match and compliment the curly lever lock set, provides the same stylish design and looks but allows versatility in its uses around the home where a latch is desired. The new Natural Textured finish will look great against a natural wooden door or stands out even better on a colourful, painted door. See page 101 for suitable latches.

83501
NATURAL
TEXTURED

CURLY LEVER BATHROOM SET

BACKPLATE SIZE: 165MM X 51MM
HANDLE LENGTH: 114MM
CENTRES: 57MM

To finish the curly lever range off we have also designed a Bathroom handle with a quality fitted, matching thumbturn for security, when used in conjunction with a bathroom mortice lock (see page 60). It means you can now complete your whole house with matching curly door furniture and in our latest textured finish. See page 101 for suitable bathroom mortice locks.



83502
NATURAL
TEXTURED



83502 - Natural textured Finish

MONKEYTAIL LEVER HANDLES



33612 (Monkeytail on Diamond), 33622 (Euro Escutcheon) & 18355/A Euro DIN Sash Lock

33279 - Black Finish

MONKEYTAIL LEVER LOCK SET

BACKPLATE SIZE: 152MM X 51MM
HANDLE LENGTH: 127MM
CENTRES: 57MM

This range of unsprung handles has a simple backplate design so all the focus is directed at the very distinctive Monkeytail handle which has been drawn from a single piece of steel to give an exquisite detail. See page 102 for suitable locks.

33900
BEESWAX

33279
BLACK

33615
PEWTER PATINA

MONKEYTAIL LEVER LATCH SET

BACKPLATE SIZE: 152MM X 51MM
HANDLE LENGTH: 127MM

A lever latch handle to compliment the lock version and allows use in a multitude of areas around the home. It's distinctive style wouldn't look out of place on any style of door, painted or natural. See page 102 for suitable latches.

33901
BEESWAX

33278
BLACK

33616
PEWTER PATINA

33901 - Beeswax Finish

MONKEYTAIL LEVER BATHROOM SET

BACKPLATE SIZE: 152MM X 51MM
HANDLE LENGTH: 127MM
CENTRES: 57MM

To finish off the monkeytail range this bathroom handle has a simple backplate design so all the focus is directed at the very distinctive Monkeytail handle, which has been drawn from a single piece of steel to give an exquisite detail. See page 102 for suitable bathroom mortice locks.

33902
BEESWAX

33266
BLACK

33617
PEWTER PATINA

33617 - Pewter Patina Finish

DIAMOND ESCUTCHEONS

See page 55 for details



MONKEYTAIL ON DIAMOND ROSETTE

ROSETTE SIZE: 76MM X 76MM
HANDLE LENGTH: 127MM

A very desirable and distinctive product which can be very versatile when used in conjunction with either a latch, lock, bathroom dead bolt, Euro or Espag. mechanism. Matching escutcheons (page 55), Diamond Thumbturns (page 56) and all locks & latches (page 101-103).

Now Finish Available

33935 - Bronze Finish

33848
BEESWAX

33235
BLACK

33612
PEWTER PATINA

33935
BRONZE

DIAMOND BATHROOM THUMBTURN

See page 56 for details



COTTAGE SPRUNG LEVER HANDLES



73106 (Cottage Lever Lock)

73106 - Black Finish

COTTAGE LEVER LOCK SET

BACKPLATE SIZE: 171MM X 51MM
HANDLE LENGTH: 89MM
CENTRES: 57MM

A very traditional looking design which incorporates a decorative 'curl' at the end of a slightly curved handle and a 'wave' design cut into the top and bottom of the backplate. See page 101 for suitable locks.

73106
BLACK

73107 - Black Finish

COTTAGE LEVER LATCH SET

BACKPLATE SIZE: 171MM X 51MM
HANDLE LENGTH: 89MM

A latch version of the traditional Cottage handle which allows versatility in it's areas of use and helps to create a uniform look throughout your home if used with the other handles in the range. See page 101 for suitable latches.

73107
BLACK

COTTAGE LEVER BATHROOM SET

BACKPLATE SIZE: 171MM X 51MM
HANDLE LENGTH: 89MM
CENTRES: 57MM

This bathroom set helps to complete the Cottage range of handles and comes complete with a fitted thumbturn, which has a smooth turning action and allows the locking of your door when used in conjunction with a bathroom mortice lock (see page 101).

73108
BLACK

73108 - Black Finish



OAK & SMOOTH LEVER HANDLES

33633 (Narrow Lever Espagnolette)

33319 - Black Finish



OAK LEVER LOCK SET

BACKPLATE SIZE: 130MM X 51MM
HANDLE LENGTH: 95MM
CENTRES: 57MM

A very traditional style, sprung handle with a decorative feature cut into the backplate and a simple, yet stylish design to the handle. See page 101 for suitable locks.

33319
BLACK

33318 - Black Finish



OAK LEVER LATCH SET

BACKPLATE SIZE: 150MM X 51MM
HANDLE LENGTH: 95MM

A latch version to compliment the very traditional style of our Oak Lock Set so the same style and feel can be re-created anywhere in the home. See page 101 for suitable latches.

33318
BLACK

33320 - Black Finish

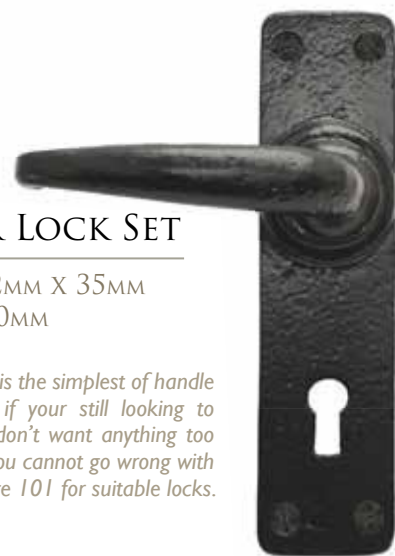

SMOOTH LEVER LOCK SET

BACKPLATE SIZE: 152MM X 35MM
HANDLE LENGTH: 90MM
CENTRES: 57MM

The Smooth sprung lever lock is the simplest of handle designs in our collection so if your still looking to create that antique feel but don't want anything too flamboyant of a design then you cannot go wrong with this solid steel handle. See page 101 for suitable locks.

33320
BLACK

SMOOTH LEVER LATCH SET

BACKPLATE SIZE: 152MM X 35MM
HANDLE LENGTH: 90MM

The Smooth sprung lever latch is the simplest of handle designs in our collection so if your still looking to create that antique feel but don't want anything too flamboyant of a design then you cannot go wrong with this solid steel handle. See page 101 for suitable latches.

33317
BLACK

33317 - Black Finish



STRAIGHT LEVER LOCK SET

BACKPLATE SIZE: 152MM X 41MM
HANDLE LENGTH: 127MM
CENTRES: 57MM

The Straight range of sprung lever handles have a very simple, square backplate which doesn't distract from the stylish round boss and the distinctive, long handle.



73113 BEESWAX **73109** BLACK **73112** ANTIQUE PEWTER



73114 - Beeswax Finish

STRAIGHT LEVER LATCH SET

BACKPLATE SIZE: 152MM X 41MM
HANDLE LENGTH: 127MM

A latch version to compliment the very stylish design of our Straight, sprung lock set so the same look and feel can be re-created anywhere in the home, including bedrooms, dining rooms and kitchens. See page 101 for suitable latches.



73114 BEESWAX **73110** BLACK



73109 (Straight Lever Lock)



STRAIGHT LEVER BATHROOM SET

BACKPLATE SIZE: 152MM X 41MM
HANDLE LENGTH: 127MM
CENTRES: 57MM

This bathroom set helps to complete the Straight range of sprung handles and comes complete with a fitted thumbturn, which has a smooth turning action and allows the locking of your door when used in conjunction with a bathroom mortice lock (see page 101).



73115 BEESWAX **73111** BLACK

73111 - Black Finish

NARROW & AVON LEVER HANDLES



33700 (Avon Lever Lock)

NARROW LEVER ESPAG. LOCK SET

BACKPLATE SIZE: 220MM X 30MM
 BACKPLATE THICKNESS: 5MM
 HANDLE LENGTH: 115MM
 CENTRES: 92MM
 FIXING CENTRES: 123MM

This narrow Espag. set has a very nice 'twist' detail in the handle and is designed to be used with multi point locks (3 point locking systems - see page 103). The handle is not sprung which allows for the upward (locking) movement commonly associated with espagnolette systems and ideal for upvc doors.



33119 BLACK **33633** PEWTER PATINA



33633 - Pewter Finish



33701 - Pewter Patina Finish

AVON LEVER LATCH SET

BACKPLATE SIZE: 152MM X 48MM
 HANDLE LENGTH: 110MM

This latch version of our very popular Avon range enables versatility for the user in areas around the home where you have no need for a locking mechanism i.e. in a lounge or dining room. See page 102 for suitable latches.



33701
 PEWTER PATINA

AVON LEVER LOCK SET

BACKPLATE SIZE: 152MM X 48MM
 HANDLE LENGTH: 110MM
 CENTRES: 57MM

A very striking, contemporary handle that looks great on any type of house, old or new & has a strong spring incorporated into the stylish boss design to give it both functionality & elegance. See page 101 for suitable locks.



33700
 PEWTER PATINA

33700 - Pewter Patina Finish

AVON LEVER BATHROOM SET

BACKPLATE SIZE: 152MM X 48MM
 HANDLE LENGTH: 110MM
 CENTRES: 57MM

A bathroom version of the stylish Avon handle which comes complete with a fitted thumbturn, has a smooth turning action and allows the locking of your door when used in conjunction with a bathroom mortice lock (see page 101).



33702
 PEWTER PATINA



33702 - Pewter Patina Finish

AVON LEVER EURO LOCK SET

BACKPLATE SIZE: 152MM X 48MM
 BACKPLATE THICKNESS: 5MM
 HANDLE LENGTH: 110MM
 CENTRES: 47MM

The Euro version of the Avon handle is designed to be used in conjunction with a euro sash lock and euro cylinder, with or without a thumbturn (see page 102) and allows your door to be locked from the inside or out. Ideal for guest rooms, hotels or replacement of existing euro handles.



33703
 PEWTER PATINA



33703 - Pewter Patina Finish

AVON LEVER ESPAG. LOCK SET

BACKPLATE SIZE: 241MM X 48MM
 BACKPLATE THICKNESS: 5MM
 HANDLE LENGTH: 110MM
 CENTRES: 92MM
 FIXING CENTRES: 215MM

An espagnolette version of the stylish Avon handle, which is designed with an extra long backplate to be used with all multi point locks (3 point locking systems - see page 103 & Euro Cylinders - see page 102). This handle is the only one of the Avon range which is not sprung and allows for upward (locking) movement of the handle but still incorporates the same, elegant boss design.



33123 BLACK **33704** PEWTER PATINA



33123 - Black Finish

GOTHIC LEVER HANDLES



33600 (Gothic Lever Lock), 33663 (Straight Door Bolt) & 33693 (4" Butt Hinge)

GOTHIC LEVER LOCK SET

BACKPLATE SIZE: 248MM X 44MM
HANDLE LENGTH: 110MM
CENTRES: 57MM

The Gothic range of handles get their name from the 'pointed arch' to the backplate, reminiscent of gothic architecture and the styled handle, turned to be seen at an angle, notched and pointed at the end only adds to that 'Gothic' effect. This lock version is ideal for a front door with a similar style but also looks great on any imposing entrance way. See page 102 for suitable locks.



33271 BEESWAX **33276** BLACK **33600** PEWTER PATINA **33942** BRONZE



33942 - Bronze Finish

GOTHIC LEVER LATCH SET

BACKPLATE SIZE: 248MM X 44MM
HANDLE LENGTH: 110MM

This latch version of our Gothic handle allows the same style to be carried throughout the home and has a multitude of areas where it can be used from dining rooms and lounges to bedrooms and kitchens. See page 102 for suitable latches.



33270 BEESWAX **33275** BLACK **33601** PEWTER PATINA **33945** BRONZE



33275 - Black Finish

GOTHIC LEVER BATHROOM SET

BACKPLATE SIZE: 248MM X 44MM
HANDLE LENGTH: 110MM
CENTRES: 57MM

This bathroom set helps to complete the Gothic range of handles and comes with a fitted thumbturn, which has a smooth turning action and allows the locking of your door when used in conjunction with a bathroom mortice lock (see page 102). Please note Beeswax & Black handles have the new 'Boss' design (see image) whereas the Pewter Patina version has the original design - Please see website for individual product images - www.fromtheanvil.co.uk



33272 BEESWAX **33274** BLACK **33604/B** PEWTER PATINA



33272 - Beeswax Finish

GOTHIC LEVER EURO LOCK SET

BACKPLATE SIZE: 248MM X 44MM
BACKPLATE THICKNESS: 5MM
HANDLE LENGTH: 110MM
CENTRES: 47MM

The euro version of the Gothic handle is designed to be used in conjunction with a euro sash lock and euro cylinder (see page 102) and allows your door to be locked from inside or outside. Ideal for patio doors or replacement of existing euro handles. Please note the Beeswax handle has the new 'Boss' design whereas the Black & Pewter Patina versions have the original design (see image) - Please see website for individual product images - www.fromtheanvil.co.uk



33269 BEESWAX **33277** BLACK **33604/47** PEWTER PATINA



33277 - Black Finish

GOTHIC LEVER ESPAG. LOCK SET

BACKPLATE SIZE: 248MM X 44MM
BACKPLATE THICKNESS: 5MM
HANDLE LENGTH: 110MM
CENTRES: 92MM
FIXING CENTRES: 192MM

An espagnolette version of the Gothic handle, which is designed to be used with multi point locks, including narrow backsets 3 point locking systems - (see page 103 & Euro Cylinders - see page 102). This handle allows for the upward (locking) movement.



33273 BLACK **33604** PEWTER PATINA



33604 - Pewter Patina Finish

GOthic CURVED SPRUNG LEVER HANDLES



33635 (Gothic Curved Lever Latch)

GOthic CURVED SPRUNG LEVER LOCK SET

BACKPLATE SIZE: 248MM X 43MM
HANDLE LENGTH: 115MM
CENTRES: 57MM

The Gothic Curved range of handles have a heavy duty spring incorporated in a stylish boss design. The backplate keeps the same pointed 'Gothic' look but with a softer, 'curved' handle design. See page 101 for suitable locks.



33136 BLACK **33634** PEWTER PATINA

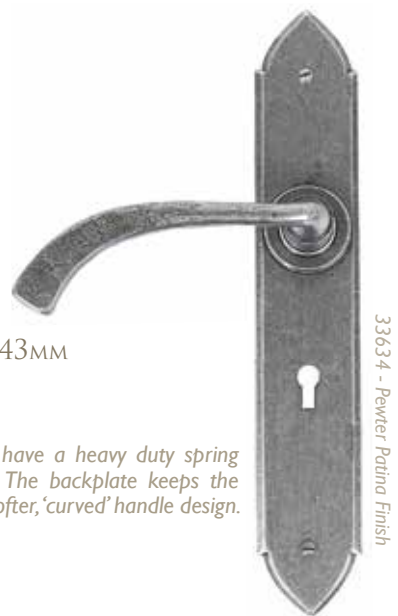

33634 - Pewter Patina Finish

GOthic CURVED SPRUNG LEVER LATCH SET

BACKPLATE SIZE: 248MM X 43MM
HANDLE LENGTH: 115MM

This latch version of our Gothic Curved handle allows the same style to be carried throughout the home and has a multitude of areas where it can be used from dining rooms and lounges to bedrooms and kitchens. See page 101 for suitable latches.



33137 BLACK **33635** PEWTER PATINA



33137 - Black Finish

GOthic CURVED SPRUNG LEVER BATHROOM SET

BACKPLATE SIZE: 248MM X 43MM
HANDLE LENGTH: 115MM
CENTRES: 57MM

This bathroom set helps to complete the Gothic Curved range of handles and comes complete with a fitted thumbturn, which has a smooth turning action and allows the locking of your door when used in conjunction with a bathroom mortice lock (see page 101).



33138 BLACK **33636** PEWTER PATINA



33636 - Pewter Patina Finish

TUDOR LEVER HANDLES



33170 (Tudor Lever Lock)

TUDOR LEVER LOCK SET

BACKPLATE SIZE: 273MM X 40MM
HANDLE LENGTH: 132MM
CENTRES: 57MM

An authentically styled Tudor lock set with a decorative backplate and an angled handle which is pointed at either end. Nothing smaller than a 3" lock would be advisable with this handle so as not to catch the end of the pointed handle on your doorstep. See page 102 for suitable locks. Please note Black handle has the new 'Boss' design whereas the Beeswax & Pewter Patina version have the original design - Please see website for individual product images - www.fromtheanvil.co.uk



33170 BEESWAX **33247** BLACK **33608** PEWTER PATINA



33170 - Beeswax Finish

TUDOR LEVER LATCH SET

BACKPLATE SIZE: 273MM X 40MM
HANDLE LENGTH: 132MM

A latch handle to compliment the lock version and allows use in a multitude of areas around the home. It's distinctive style wouldn't look out of place on any style of door, painted or natural. A minimum size of a 3" latch is advisable (see page 102). Please note Beeswax handle has the new 'Boss' design whereas the Black & Pewter Patina version have the original design - Please see website for individual product images - www.fromtheanvil.co.uk



33171 BEESWAX **33173** BLACK **33609** PEWTER PATINA



33609 - Pewter Patina Finish

TUDOR LEVER ESPAG. LOCK SET

BACKPLATE SIZE: 273MM X 40MM
BACKPLATE THICKNESS: 5MM
HANDLE LENGTH: 132MM
CENTRES: 92MM
FIXING CENTRES: 243MM

The espag. version compliments the range and is designed to be used with 3 point locking systems - (see page 103 & Euro Cylinders - see page 102) which has a minimum backset of 45mm. The handle is not sprung which allows for the upward (locking) movement commonly associated with espagnolette systems.



33172 BLACK



33172 - Black Finish

CROMWELL LEVER HANDLES



33117 (Cromwell Lever Latch)

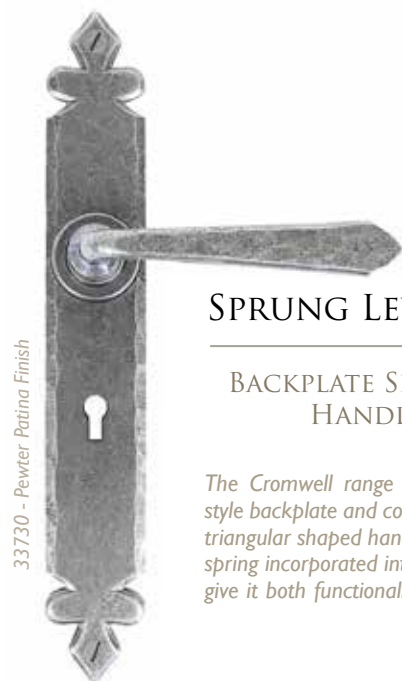

33730 - Pewter Patina Finish

CROMWELL SPRUNG LEVER LOCK SET

BACKPLATE SIZE: 270MM X 40MM
HANDLE LENGTH: 115MM
CENTRES: 57MM

The Cromwell range of handles have a "Tudor" style backplate and come with a slightly flattened, triangular shaped handle. They also have a strong spring incorporated into the stylish boss design to give it both functionality and elegance. See page 101 for suitable locks.



33116 **33730**
BLACK PEWTER PATINA



33116 - Black Finish

CROMWELL SPRUNG LEVER LATCH SET

BACKPLATE SIZE: 270MM X 40MM
HANDLE LENGTH: 115MM

A latch version of the elegant Cromwell handle which allows versatility in it's areas of use and helps to create a uniform look throughout your home when used with the other handles in the range. See page 101 for suitable latches.



33117 **33731**
BLACK PEWTER PATINA



33732 - Pewter Patina Finish

CROMWELL SPRUNG LEVER BATHROOM SET

BACKPLATE SIZE: 270MM X 40MM
HANDLE LENGTH: 115MM
CENTRES: 57MM

This bathroom set helps to complete the Cottage range of handles and comes complete with a fitted thumbturn, which has a smooth turning action and allows the locking of your door when used in conjunction with a bathroom mortice lock (see page 101).



33118 **33732**
BLACK PEWTER PATINA

PULL HANDLES

GOthic D HANDLES - Page 40

BEAN D HANDLES - Page 41

HAMMERED D HANDLES - Page 42

SHELL PULL HANDLES - Page 43

RIBBED PULL HANDLES - Page 44

DRAWER PULL HANDLES - Page 45

DROP HANDLE - Page 45

CABINET HANDLE - Page 45



33640

33641



GOTHIC D HANDLES

33995 (6" Gothic D Handle)

8" GOTHIC D HANDLE

OVERALL SIZE: 203MM X 44MM
INTERNAL SIZE: 121MM

Can be used on full size doors, cupboards or drawers. Our blacksmiths fashion these D-handles with great skill from a single piece of steel forming the Gothic end. Supplied with all fixing screws.



33153 BEESWAX **33996** BLACK **33642** PEWTER PATINA



33642 - Pewter Patina Finish

8" BEAN D HANDLE

OVERALL SIZE: 203MM X 57MM
INTERNAL SIZE: 114MM

Can be used on full size doors, cupboards or drawers. Our blacksmiths fashion these D-handles with great skill from a single piece of steel forming the Bean end. Supplied with all fixing screws.



33167 BEESWAX **33999** BLACK **33647** PEWTER PATINA



33647 - Pewter Patina Finish



BEAN D HANDLES

33646 (Bean D Handle)

6" GOTHIC D HANDLE

OVERALL SIZE: 152MM X 38MM
INTERNAL SIZE: 76MM

Can be used on full size doors, cupboards or drawers. Our blacksmiths fashion these D-handles with great skill from a single piece of steel forming the Gothic end. Supplied with all fixing screws.



33152 BEESWAX **33995** BLACK **33641** PEWTER PATINA



33995 - Black Finish

4" GOTHIC D HANDLE

OVERALL SIZE: 101MM X 25MM
INTERNAL SIZE: 51MM

Can be used on full size doors, cupboards or drawers. Our blacksmiths fashion these D-handles with great skill from a single piece of steel forming the Gothic end. Supplied with all fixing screws.



33151 BEESWAX **33994** BLACK **33640** PEWTER PATINA



33151 - Beeswax Finish

4" BEAN D HANDLE

OVERALL SIZE: 101MM X 25MM
INTERNAL SIZE: 51MM

Can be used on full size doors, cupboards or drawers. Our blacksmiths fashion these D-handles with great skill from a single piece of steel forming the Bean end. Supplied with all fixing screws.



33168 BEESWAX **33997** BLACK **33645** PEWTER PATINA



33168 - Beeswax Finish

6" BEAN D HANDLE

OVERALL SIZE: 152MM X 38MM
INTERNAL SIZE: 82MM

Can be used on full size doors, cupboards or drawers. Our blacksmiths fashion these D-handles with great skill from a single piece of steel forming the Bean end. Supplied with all fixing screws.



33169 BEESWAX **33998** BLACK **33646** PEWTER PATINA



33998 - Black Finish



HAMMERED D HANDLES

33646 (Bean D Handle)

5" HAMMERED D HANDLE

OVERALL SIZE: 124MM X 25MM
INTERNAL SIZE: 90MM
PROJECTION: 40MM

A smaller, decorative D Handle with a hammered centre feature fashioned from cast iron and has a smooth natural iron finish. Supplied with fixing screws. Matching knobs on page 76.



83527
NATURAL SMOOTH



83527 - Natural Smooth Finish

10" HAMMERED D HANDLE

OVERALL SIZE: 252MM X 25MM
INTERNAL SIZE: 218MM
PROJECTION: 46MM

A medium, decorative D Handle with a hammered centre feature fashioned from cast iron and has a smooth natural iron finish. Supplied with fixing screws. Matching knobs on page 76.



83528
NATURAL SMOOTH



83528 - Natural Smooth Finish

13 1/2" HAMMERED D HANDLE

OVERALL SIZE: 346MM X 25MM
INTERNAL SIZE: 311MM
PROJECTION: 49MM

A large, decorative D Handle with a hammered centre feature fashioned from cast iron and has a smooth natural iron finish. Supplied with fixing screws. Matching knobs on page 76.



83529
NATURAL SMOOTH



83529 - Natural Smooth Finish



83519 (4" Drawer Pull)

SHELL PULL HANDLES

7" SHELL PULL HANDLE

OVERALL SIZE: 176MM X 22MM
INTERNAL SIZE: 149MM
PROJECTION: 33MM

A stylish medium sized pull handle which tapers towards the middle and has a very simple shell like design. Fashioned from cast iron and has a smooth natural iron finish. Supplied with concealed fixing screws. Matching knobs on page 77.



83534
NATURAL SMOOTH



83534 - Natural Smooth Finish

Alternative View



4" DRAWER PULL

OVERALL SIZE: 101MM X 47MM
INTERNAL SIZE: 75MM
PROJECTION: 30MM

A simple yet stylish pull handle ideal for cupboard doors, cabinets and drawer fronts. Fashioned from cast iron and has a smooth natural iron finish. Supplied with concealed fixing screws. Matching knobs on page 77.



83519
NATURAL SMOOTH

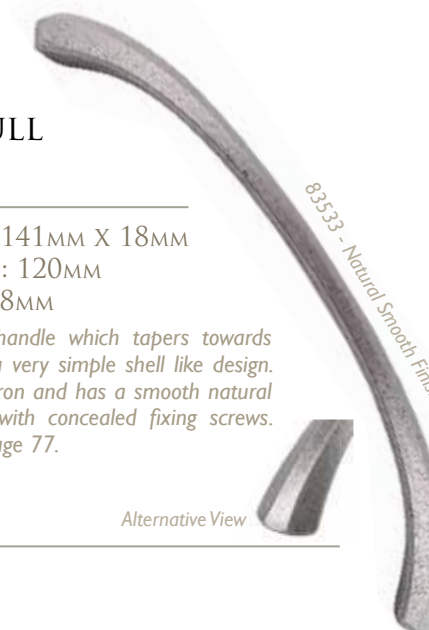

83533 - Natural Smooth Finish

Alternative View

5" SHELL PULL HANDLE

OVERALL SIZE: 141MM X 18MM
INTERNAL SIZE: 120MM
PROJECTION: 28MM

A stylish small pull handle which tapers towards the middle and has a very simple shell like design. Fashioned from cast iron and has a smooth natural iron finish. Supplied with concealed fixing screws. Matching knobs on page 77.



83533
NATURAL SMOOTH



RIBBED PULL HANDLES

83532 (9" Ribbed Pull Handle)



PULL HANDLES

83517 (Drawer Pull)



83517 - Natural Smooth Finish

DRAWER PULL

OVERALL SIZE: 102MM X 44MM
INTERNAL SIZE: 69MM
PROJECTION: 22MM

A very decorative drawer pull with intricate detailing. It has been polished to a very high sheen and shows the superb, natural metal colour. Looks great against painted or natural wood in a kitchen or bedroom. Comes supplied with fixing screws.

83517
NATURAL
SMOOTH

5 1/2" RIBBED PULL HANDLE

OVERALL SIZE: 136MM X 18MM
INTERNAL SIZE: 122MM
PROJECTION: 27MM

A stylish small pull handle with a very simple 'Ribbed' design along the edge. Fashioned from cast iron and has a smooth natural iron finish. Supplied with concealed fixing screws. Matching knobs on page 77.



83530
NATURAL
SMOOTH



DRAWER PULL

OVERALL SIZE: 98MM X 51MM
INTERNAL SIZE: 65MM
PROJECTION: 22MM

A traditional style of drawer pull given a new lease of life with the highly polished Natural Smooth finish. A high quality product which has a multitude of uses around the home. Supplied complete with fixing screws.



83520
NATURAL
SMOOTH



83520 - Natural Smooth Finish

9" RIBBED PULL HANDLE

OVERALL SIZE: 232MM X 18MM
INTERNAL SIZE: 216MM
PROJECTION: 30MM

A stylish large pull handle with a very simple 'Ribbed' design along the edge. Fashioned from cast iron and has a smooth natural iron finish. Supplied with concealed fixing screws. Matching knobs on page 77.



83532
NATURAL
SMOOTH

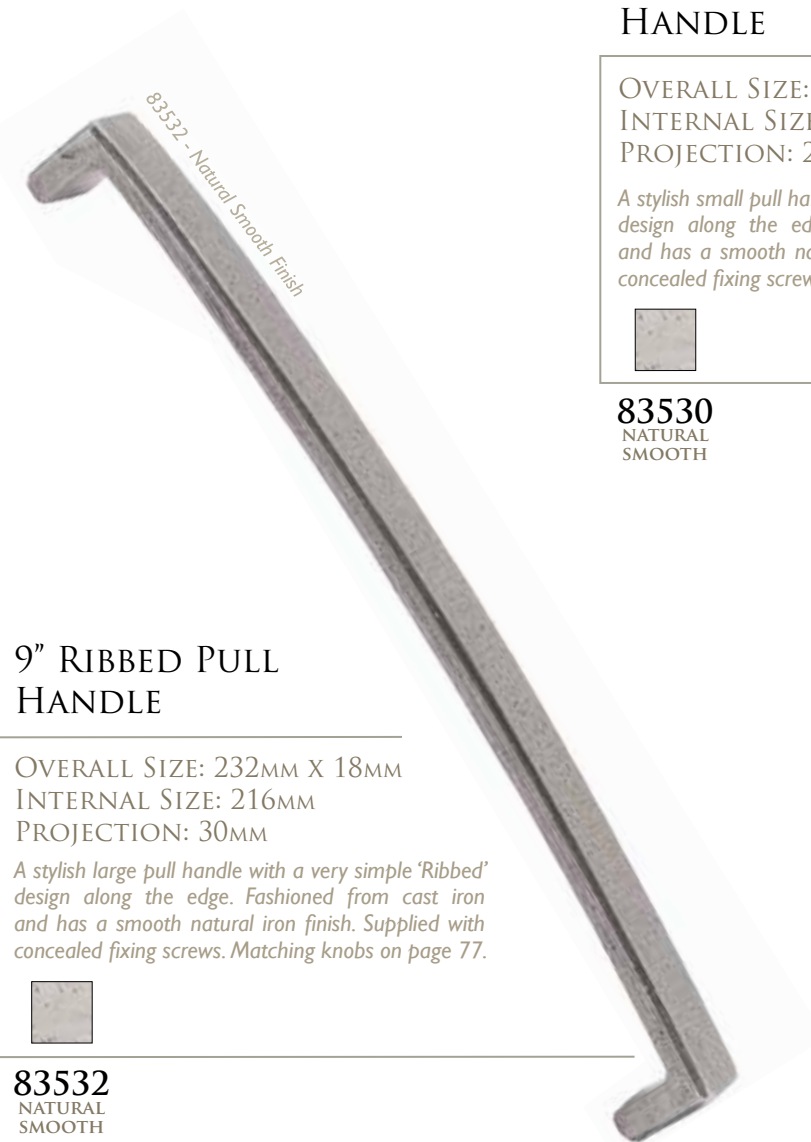

83535 - Natural Smooth Finish

DROP HANDLE

OVERALL SIZE: 144MM X 44MM
INTERNAL SIZE: 95MM
FIXING PLATES: 25MM X 25MM

A traditional style of handle which drops down when not in use and adds a touch of class to any drawer front in a kitchen, dining room or study. The Natural Smooth finish will compliment a whole host of bright colours and wood styles. Supplied complete with M4 screws.



83535
NATURAL
SMOOTH

CABINET HANDLE

OVERALL SIZE: 79MM X 44MM
PROJECTION: 44MM

The Natural Smooth finish breathes new life into a traditional style of cabinet handle and helps to create a stylish, uniform look when used in conjunction with our other Natural Smooth products. Supplied complete with an M4 screw.



83531
NATURAL
SMOOTH



83531 - Natural Smooth Finish



RIM/MORTICE DOOR KNOBS

- ROUND KNOBS - Page 47
- OCTAGONAL KNOBS - Page 47
- OVAL KNOBS - Page 47
- RINGED KNOB - Page 48
- BUN KNOB - Page 48
- MUSHROOM KNOB - Page 48
- FLOWER KNOBS - Page 49



ROUND, OCTAGONAL & OVAL MORTICE/RIM KNOB SETS

33643 (Octagonal Mortice/Rim Knob Set)

ROUND MORTICE/RIM KNOB SET

KNOB SIZE: 41MM
 PROJECTION: 70MM
 ROSE SIZE: 60MM
 SPINDLE SIZE: 8MM (THREADED)

Supplied complete with two loose roses to enable them to be used with a large rim lock (pages 50-53) or mortice locks (page 102), two round knobs and two escutcheons. Threaded spindles for various door thicknesses (up to 60mm) and fixing screws.



33230 BEESWAX **33252** BLACK **33778** PEWTER PATINA

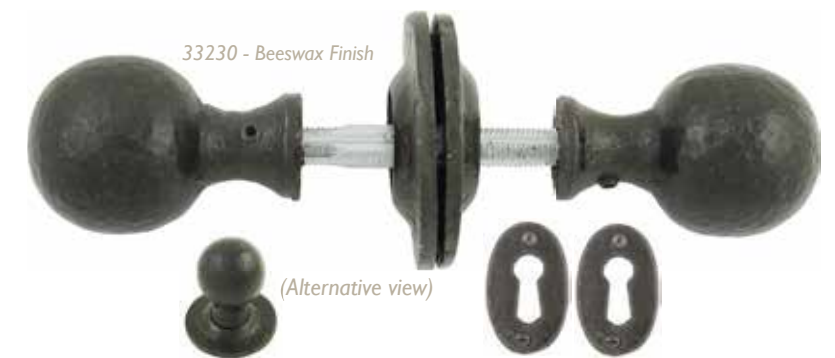

OCTAGONAL MORTICE/RIM KNOB SET

KNOB SIZE: 54MM
 PROJECTION: 63MM
 ROSE SIZE: 57MM
 SPINDLE SIZE: 8MM (THREADED)

Supplied complete with two loose roses to enable them to be used with a large rim lock (pages 50-53) or mortice locks (page 102), two octagonal knobs and two escutcheons. Threaded spindles for various door thicknesses (up to 60mm) and fixing screws.

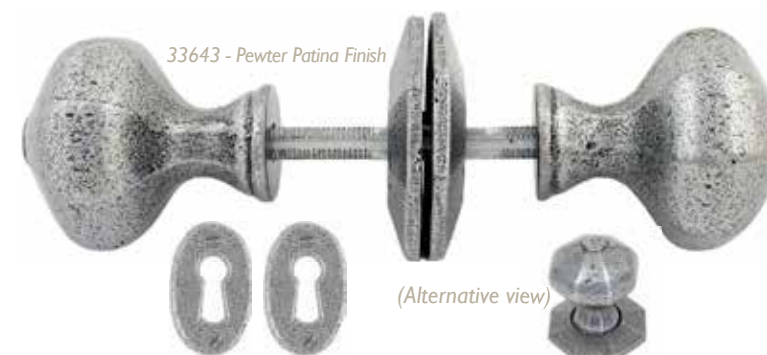

33228 BEESWAX **33250** BLACK **33643** PEWTER PATINA

OVAL MORTICE/RIM KNOB SET

KNOB SIZE: 63MM X 38MM
 PROJECTION: 54MM
 ROSE SIZE: 60MM
 SPINDLE SIZE: 8MM (THREADED)

Supplied complete with two loose roses to enable them to be used with a large rim lock (pages 50-53) or mortice locks (page 102), two oval knobs and two escutcheons. Threaded spindles for various door thicknesses (up to 60mm) and fixing screws.



33229 BEESWAX **33251** BLACK **33644** PEWTER PATINA **33911** BRONZE

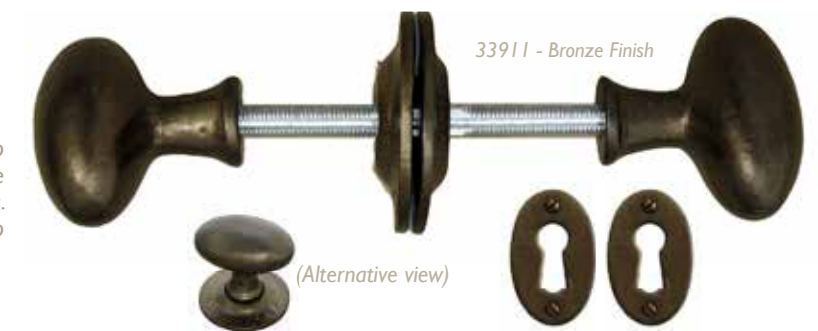



RINGED, BUN & MUSHROOM MORTICE/RIM KNOB SETS

83563 (Bun Rim Knob) & 83591 (Left Hand Rim Lock)

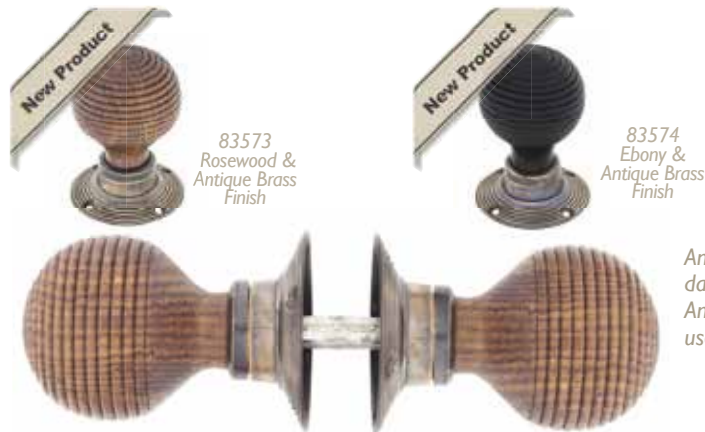

83573 - Rosewood & Antique Brass Finish

BEEHIVE MORTICE/RIM KNOB SET

KNOB SIZE: 58MM DIA.
PROJECTION: 83MM
ROSE SIZE: 58MM
SPINDLE SIZE: 8MM (THREADED)

An attractive Beehive Knob Set in either a richly hued Rosewood or a rich and dark Ebonised Finish. Supplied complete with detachable roses in a stylish Antique Brass Finish, a threaded spindle and matching fixing screws. Ideal for use with rim locks (pages 51-53) or mortice locks or latches (pages 101-102).



83574
EBONY
& ANTIQUE BRASS

83573
ROSEWOOD
& ANTIQUE BRASS

BEEHIVE & HEAVY BEEHIVE MORTICE/RIM KNOB SET

KNOB SIZE: 67MM X 54MM DIA.
PROJECTION: 67MM
ROSE SIZE: 57MM
SPINDLE SIZE: 8MM (THREADED)

An attractive Beehive Knob Set in either a stylish Antique Brass Finish or a highly Polished Nickel Finish, with a choice of normal (hollow) or heavy (solid) feel. Supplied complete with detachable roses in a matching Finish, a threaded spindle and matching fixing screws. Ideal for use with rim locks (pages 51-53) or mortice locks or latches (pages 101-102).



83633
ANTIQUÉ
BRASS

83636
POLISHED
NICKEL

83633H
ANTIQUÉ
BRASS

83636H
POLISHED
NICKEL



83633 - Antique Brass Finish

RINGED MORTICE/RIM KNOB SET

KNOB SIZE: 70MM X 54MM DIA.
PROJECTION: 70MM
ROSE SIZE: 67MM
SPINDLE SIZE: 8MM (THREADED)

An attractive, richly hued ringed Rosewood knob set. Supplied complete with detachable brass roses, two lengths of threaded spindle (120mm for use with rim locks - page 52 & 100mm for use with mortice locks & latches - page 102) and brass fixing screws.



83562
ROSEWOOD

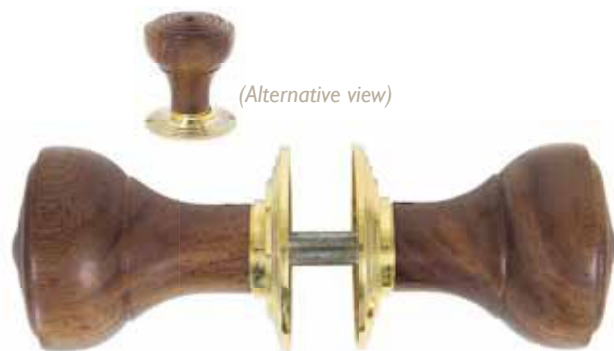

83562 - Rosewood Finish



FLOWER MORTICE KNOB SETS

83561 (Flower Mortice Knob) & 33665 (Oval Escutcheon)

BUN MORTICE/RIM KNOB SET

KNOB SIZE: 67MM X 54MM DIA.
PROJECTION: 67MM
ROSE SIZE: 57MM
SPINDLE SIZE: 8MM (THREADED)

A rich, dark Ebonised bun knob set. Supplied complete with detachable brass roses, two lengths of threaded spindle (120mm for use with rim locks - page 52 & 100mm for use with mortice locks & latches - page 102) and brass fixing screws.



83563
EBONY



83563 - Ebony Finish

MUSHROOM MORTICE/RIM KNOB SET

KNOB SIZE: 51MM X 51MM DIA.
PROJECTION: 51MM
ROSE SIZE: 51MM
SPINDLE SIZE: 8MM (THREADED)

Polished unlacquered brass knob set in very traditional mushroom style. Suitable to be used on any of our Rim Locks and looks particularly good on the Iron versions. Can also be used on their own with a latch and comes supplied with loose roses, two lengths of threaded spindle (120mm for use with rim locks - page 52 & 100mm for use with mortice locks & latches - page 102) and brass fixing screws.



83564
POLISHED
BRASS



83564 - Polished Brass Finish

FLOWER MORTICE KNOB SET

KNOB SIZE: 76MM X 57MM DIA.
PROJECTION: 76MM
ROSE SIZE: 60MM
SPINDLE SIZE: 90MM X 7MM

A traditional and classic 'flower' design has been given a new lease of life with two of our finishes, including the very desirable Natural Smooth. Can be matched up with our other Natural Smooth finished items to create a uniform look around the home. Use in conjunction with mortice locks & latches (page 102). Comes supplied as a set with two knobs and a spindle.



83561
NATURAL
SMOOTH

83560
BLACK



FLOWER MORTICE KNOB SET

KNOB SIZE: 70MM X 50MM DIA.
PROJECTION: 67MM
ROSE SIZE: 60MM
SPINDLE SIZE: 8MM (THREADED)

A classic 'flower' design in a traditional unlacquered Polished Brass finish. Can be matched up with our other Brass finish items to create a uniform look around the home. Use in conjunction with mortice locks & latches (page 102). Comes supplied as a set with two knobs and a spindle.



39010
POLISHED
BRASS



BOX & RIM LOCKS

OAK BOX LOCK - Page 51

RIM LOCK & COVER - Page 51

SPARE KEEPS - Page 51

RIM LOCKS - Page 52-53

BATHROOM RIM LATCHES - Page 53



33005



33004 - Pewter Patina Finish

OAK BOX LOCK & OCTAGONAL KNOB SET

Made from English oak, unstained and contains a five-lever British lock which offers excellent security. This product is reversible and comes complete with octagonal knobs and separate roses. For use on doors with a maximum thickness of 44mm. Thicker doors can be accommodated but you will need to contact us for an extra long key and spindle (chargeable service).

BOX LOCK: 223MM X 172MM
KEEP SIZE: 223MM X 36MM
FIXING CENTRES: 245MM
STRAP LENGTH: 262MM
SPINDLE CENTRE: 130MM
LOCK CENTRE: 60MM



33005
BLACK



33004
PEWTER PATINA



BOX LOCK, RIM LOCK & COVER AND SPARE KEEPS

33005 (Oak Box Lock - External View)

RIM LOCK & CAST IRON COVER

RIM LOCK: 158MM X 103MM
KEEP SIZE: 103MM X 21MM
FIXING CENTRES: 133MM
SPINDLE CENTRE: 115MM
LOCK CENTRE: 53MM

This product consists of a two lever rim lock with a cast iron cover over the top. The lock mechanism is not insurance rated. This set is reversible and comes without knobs.



33180
BEESWAX



33299
BLACK
SPARE KEEP
33201



33180 - Beeswax Finish



33161 - Beeswax Finish

LARGE KEEP

SIZE: 108MM X 29MM
Spare keep or use as drawer pulls. Internal size of 89mm.



33161
BEESWAX



33156 - Beeswax Finish

MEDIUM KEEP

SIZE: 108MM X 22MM
Spare keep or use as drawer pulls. Internal size of 67mm.



33156
BEESWAX

RIM LOCK & COVER

RIM LOCK: 154MM X 108MM
KEEP SIZE: 108MM X 20MM
FIXING CENTRES: 132MM
SPINDLE CENTRE: 108MM
LOCK CENTRE: 44MM

This product consists of a two lever rim lock with a solid brass cover over the top. The lock mechanism is not insurance rated. This set is reversible and comes without knobs.



35000
POLISHED BRASS



35000 - Polished Brass Finish



33157 - Beeswax Finish

SMALL KEEP

SIZE: 102MM X 19MM
Spare keep or use as drawer pulls. Internal size of 54mm.



33157
BEESWAX



RIM LOCKS & BATHROOM LATCHES

83585 (Left Hand Rim Lock)



LEFT HAND RIM LOCK - SMALL

RIM LOCK SIZE: 140MM X 86MM
 SPINDLE CENTRE: 97MM
 LOCK CENTRE: 42MM

A traditional, smaller style rim lock which keeps the very heavy, solid feel to it. Cast from solid brass, or iron, with quality brass movements inside to produce a weighty, victorian style lock. Comes with two solid brass keys. Maximum door thickness of 50mm.



83577
 POLISHED
 BRASS

83583
 IRON

RIGHT HAND RIM LOCK - SMALL

RIM LOCK SIZE: 140MM X 86MM
 SPINDLE CENTRE: 97MM
 LOCK CENTRE: 42MM

A traditional, smaller style rim lock which keeps the very heavy, solid feel to it. Cast from solid brass, or iron, with quality brass movements inside to produce a weighty, victorian style lock. Comes with two solid brass keys. Maximum door thickness of 50mm.



83580
 POLISHED
 BRASS

83584
 IRON

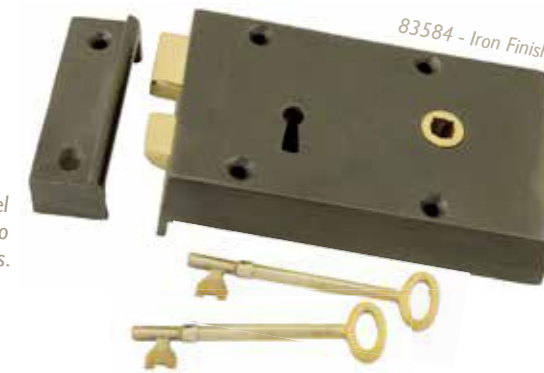

LEFT HAND RIM LOCK - LARGE

RIM LOCK SIZE: 180MM X 112MM
 SPINDLE CENTRE: 137MM
 LOCK CENTRE: 60MM

A large traditional style rim lock which has a very heavy, solid feel to it. Cast from solid brass, or iron, with quality brass movements inside to produce a weighty, victorian style lock. Comes with two solid brass keys. Maximum door thickness of 55mm.



83585
 POLISHED
 BRASS

83591
 IRON



LEFT HAND BATHROOM LATCH

RIM LOCK SIZE: 128MM X 79MM
 SPINDLE CENTRE: 92MM

A traditional style bathroom or bedroom latch which has a heavy, solid feel to it. Cast from solid brass or iron with quality brass movements inside and a draw bolt at the top for slide across locking to produce a classy, victorian style latch.



83570
 POLISHED
 BRASS

83575
 IRON

RIGHT HAND RIM LOCK - LARGE

RIM LOCK SIZE: 180MM X 112MM
 SPINDLE CENTRE: 137MM
 LOCK CENTRE: 60MM

A large traditional style rim lock which has a very heavy, solid feel to it. Cast from solid brass, or iron, with quality brass movements inside to produce a weighty, victorian style lock. Comes with two solid brass keys. Maximum door thickness of 55mm.



83588
 POLISHED
 BRASS

83592
 IRON

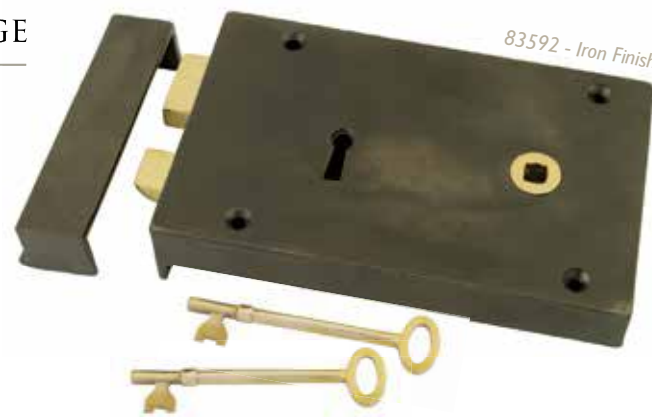

RIGHT HAND BATHROOM LATCH

RIM LOCK SIZE: 128MM X 79MM
 SPINDLE CENTRE: 92MM

A traditional style bathroom or bedroom latch which has a heavy, solid feel to it. Cast from solid brass or iron with quality brass movements inside and a brass draw bolt at the top for slide across locking to produce a classy, victorian style latch.



83571
 POLISHED
 BRASS

83576
 IRON

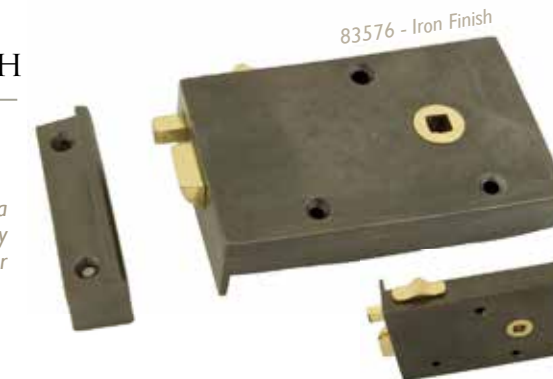

ESCUTCHEONS & THUMBTURNS

- OVAL ESCUTCHEON - Page 55
- OVAL ESCUTCHEON COVER - Page 55
- DIAMOND ESCUTCHEON - Page 55
- DIAMOND EURO ESCUTCHEON - Page 55
- BEEHIVE ESCUTCHEON - Page 56
- PLAIN ESCUTCHEON - Page 56
- DIAMOND THUMBTURN - Page 56



33265



OVAL & DIAMOND ESCUTCHEONS

33613 (Diamond Escutcheon), 33612 (Monkeytail on Diamond) & 33007 (Horizontal Sash Lock)

OVAL ESCUTCHEON

OVERALL SIZE: 51MM X 29MM
THICKNESS: 2.5MM



33231 BEESWAX 33255 BLACK 33665 PEWTER PATINA



33231 - Beeswax Finish

OVAL ESCUTCHEON & COVER

OVERALL SIZE: 51MM X 29MM
THICKNESS: 2.5MM
COVER THICKNESS: 5MM



33232 BEESWAX 33254 BLACK 33664 PEWTER PATINA



33254 - Black Finish

DIAMOND ESCUTCHEON

OVERALL SIZE: 41MM
THICKNESS: 2.5MM

Can be used in conjunction with Monkeytail on Diamond Rosette (see page 28).



33965 BLACK 33613 PEWTER PATINA 33946 BRONZE



33613 - Pewter Patina Finish

DIAMOND EURO ESCUTCHEON

OVERALL SIZE: 51MM
THICKNESS: 2.5MM

Can be used in conjunction with Monkeytail on Diamond Rosette (see page 28).



33236 BLACK 33622 PEWTER PATINA 33948 BRONZE



33948 - Bronze Finish

BEEHIVE/PLAIN ESCUTCHEONS & DIAMOND BATHROOM THUMBTURN



83554 (Beehive Escutcheon)

BEEHIVE ESCUTCHEON

OVERALL SIZE: 57MM X 25MM

A solid brass, decorative escutcheon plate with an intricate beehive style cover to stop wind from blowing in. Comes supplied with slotted brass screws.



83554
POLISHED
BRASS



83555
ROSEWOOD



83556
EBONY

PLAIN ESCUTCHEON

OVERALL SIZE: 48MM X 29MM

A solid brass, plain yet stylish escutcheon plate with a simple, oval cover to stop wind from blowing in. Comes supplied with slotted brass screws.



83557
POLISHED
BRASS



83558
ROSEWOOD



83559
EBONY



DIAMOND BATHROOM THUMBTURN

FIXING PLATE: 51MM
PROJECTION: 35MM
SPINDLE SIZE: 5MM

Can be used in conjunction with Monkeytail on Diamond Rosette (see page 28) or as a stand alone item with deadbolts (see page 102).



33265
BEESWAX



33964
BLACK



18336
PEWTER PATINA



33950
BRONZE



DOOR KNOCKERS

PEAR SHAPED DOOR KNOCKER - Page 58

RING DOOR KNOCKER - Page 58





PEAR & RING
DOOR KNOCKERS

33611 (Pear Shaped Door Knocker) & 33696 (Pyramid Door Studs)

PEAR SHAPED DOOR KNOCKER

RING WIDTH: 95MM
RING LENGTH: 133MM
FIXING PLATE: 63MM

The Pear shaped ring has been drawn from a single piece of steel to make it stronger. It shows every hammer blow by our highly skilled craftsmen and has an interesting twist detail at the bottom.



33218 BEESWAX **33246** BLACK **33611** PEWTER PATINA



33246 - Black Finish

RING DOOR KNOCKER

RING SIZE: 114MM
FIXING PLATE: 121MM X 121MM

The ring has been drawn from a single piece of steel which makes it very heavy and strong. It shows every hammer blow by our highly skilled craftsmen.



33217 BEESWAX **33245** BLACK **33658** PEWTER PATINA **33908** BRONZE



33658 - Pewter Patina Finish



33921

LETTERPLATES & COVERS

- HANDMADE LETTERPLATE - Page 60
- HANDMADE LETTERPLATE COVER - Page 60
- POSTAL LETTERPLATE - Page 61
- ART DECO LETTERPLATE - Page 61



HANDMADE LETTERPLATES & LETTERPLATE COVERS

33226 (Letterplate) & 33250 (Octagonal Mortice/Rim Knob)



83544 (Postal Letterplate)

LETTERPLATE

OVERALL SIZE: 324MM X 108MM
 OPENING SIZE: 260MM X 44MM
 FIXING CENTRES: 292MM

A sprung loaded large heavy duty letterplate with a rustic finish.



33209 BEESWAX **33226** BLACK **33680** PEWTER PATINA **33921** BRONZE



33680 - Pewter Patina Finish

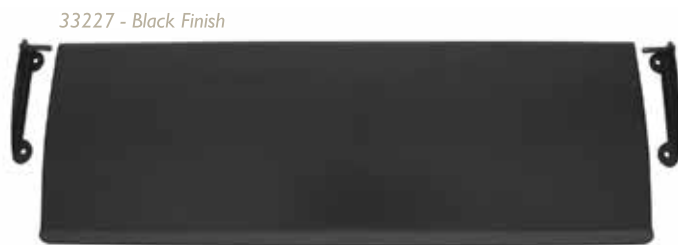

33227 - Black Finish

LETTERPLATE COVER

OVERALL SIZE: 355MM X 127MM

This letterplate cover reduces drafts and helps to tidy up and improve the inside view of your door.



33210 BEESWAX **33227** BLACK **33681** PEWTER PATINA **33922** BRONZE

POSTAL & ART DECO LETTERPLATES



83544 - Polished Brass Finish

POSTAL LETTERPLATE

OVERALL SIZE: 300MM X 115MM
 OPENING SIZE: 204MM X 40MM
 FIXING CENTRES: 250MM

A decorative letterplate made from solid brass which also incorporates a traditional style, yet ornate door knocker. This product is unlacquered.



83544
 POLISHED
 BRASS

ART DECO LETTERPLATE

OVERALL SIZE: 304MM X 85MM
 OPENING SIZE: 200MM X 48MM
 FIXING CENTRES: 253MM

A simple yet stylish, Art Deco inspired letterplate made from solid brass which also incorporates a traditional door knocker. This product is unlacquered.



83545
 POLISHED
 BRASS



83545 - Polished Brass Finish



NAILS, STUDS & DOOR GRILLS

- ROSEHEAD NAILS - Page 63
- HANDMADE NAILS - Page 63
- PYRAMID DOOR STUDS - Page 64
- RAISED DOOR GRILL - Page 64

3" ROSEHEAD NAIL

SIZE: 82MM
HEAD SIZE: 11MM X 8MM

Finished with black oxide. Externally may be prone to grey staining and bleeding, especially in oak. Sold in kilos - Average quantity 84



28338
BLACK OXIDE

2.5" ROSEHEAD NAIL

SIZE: 67MM
HEAD SIZE: 10MM X 7MM

Finished with black oxide. Externally may be prone to grey staining and bleeding, especially in oak. Sold in kilos - Average quantity 105



28335
BLACK OXIDE

2" ROSEHEAD NAIL

SIZE: 54MM
HEAD SIZE: 11MM X 8MM

Finished with black oxide. Externally may be prone to grey staining and bleeding, especially in oak. Sold in kilos - Average quantity 158



28336
BLACK OXIDE

1.5" ROSEHEAD NAIL

SIZE: 40MM
HEAD SIZE: 8MM X 7MM

Finished with black oxide. Externally may be prone to grey staining and bleeding, especially in oak. Sold in kilos - Average quantity 320



28337
BLACK OXIDE

1" ROSEHEAD NAIL

SIZE: 25MM
HEAD SIZE: 7MM X 7MM

Finished with black oxide. Externally may be prone to grey staining and bleeding, especially in oak. Sold in kilos - Average quantity 475

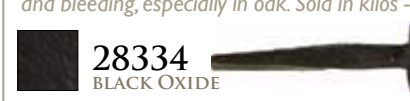

28334
BLACK OXIDE

1" HANDMADE NAIL

HEAD DIAMETER: 16MM

Fashioned from a single piece of steel for strength. If used externally will cause grey staining and bleeding. Sold in singles.



33191
BEESWAX

ROSEHEAD & HANDMADE NAILS



Rosehead Nails, Handmade Nails & Pyramid Door Studs

3" HANDMADE NAIL

HEAD DIAMETER: 25MM

Pewter & Black can be used externally and are less prone to grey staining and bleeding. Sold in singles.



33135
BEESWAX

33833
BLACK

33776
PEWTER

Fashioned from a single piece of steel for strength.

2" HANDMADE NAIL

HEAD DIAMETER: 22MM

Pewter & Black can be used externally and are less prone to grey staining and bleeding. Sold in singles.



33134
BEESWAX

33832
BLACK

33775
PEWTER

Fashioned from a single piece of steel for strength.

1" HANDMADE NAIL

HEAD DIAMETER: 19MM

Pewter & Black can be used externally and are less prone to grey staining and bleeding. Sold in singles.



33192
BEESWAX

33831
BLACK

33777
PEWTER

Fashioned from a single piece of steel for strength.

DOOR GRILL & STUDS



33155 (Door Grill)

PYRAMID DOOR STUD - LARGE

SIZE: 25MM X 25MM
 Pyramid door studs are easily fitted by way of a drive in-spike, unlike other studs on the market which have screw fixings.

33696 - Pewter Patina Finish

33195 BLACK 33696 PEWTER PATINA

PYRAMID DOOR STUD - MEDIUM

SIZE: 22MM X 22MM
 Pyramid door studs are easily fitted by way of a drive in-spike, unlike other studs on the market which have screw fixings.

33194 - Black Finish

33194 BLACK 33695 PEWTER PATINA

PYRAMID DOOR STUD - SMALL

SIZE: 15MM X 15MM
 Pyramid door studs are easily fitted by way of a drive in-spike, unlike other studs on the market which have screw fixings.

33694 - Pewter Patina Finish

33193 BLACK 33694 PEWTER PATINA



33155 - Black Finish

RAISED DOOR GRILL

OVERALL SIZE: 171MM X 171MM
 INTERNAL SIZE: 102MM X 102MM
 PROJECTION: 44MM

A very traditional item of door furniture that has been hand forged in steel to give strength and a quality unsurpassed by other door grills on today's market. Ideal for an imposing front or back door and gives the entrance to your home the feeling of grandeur.



33155 BLACK

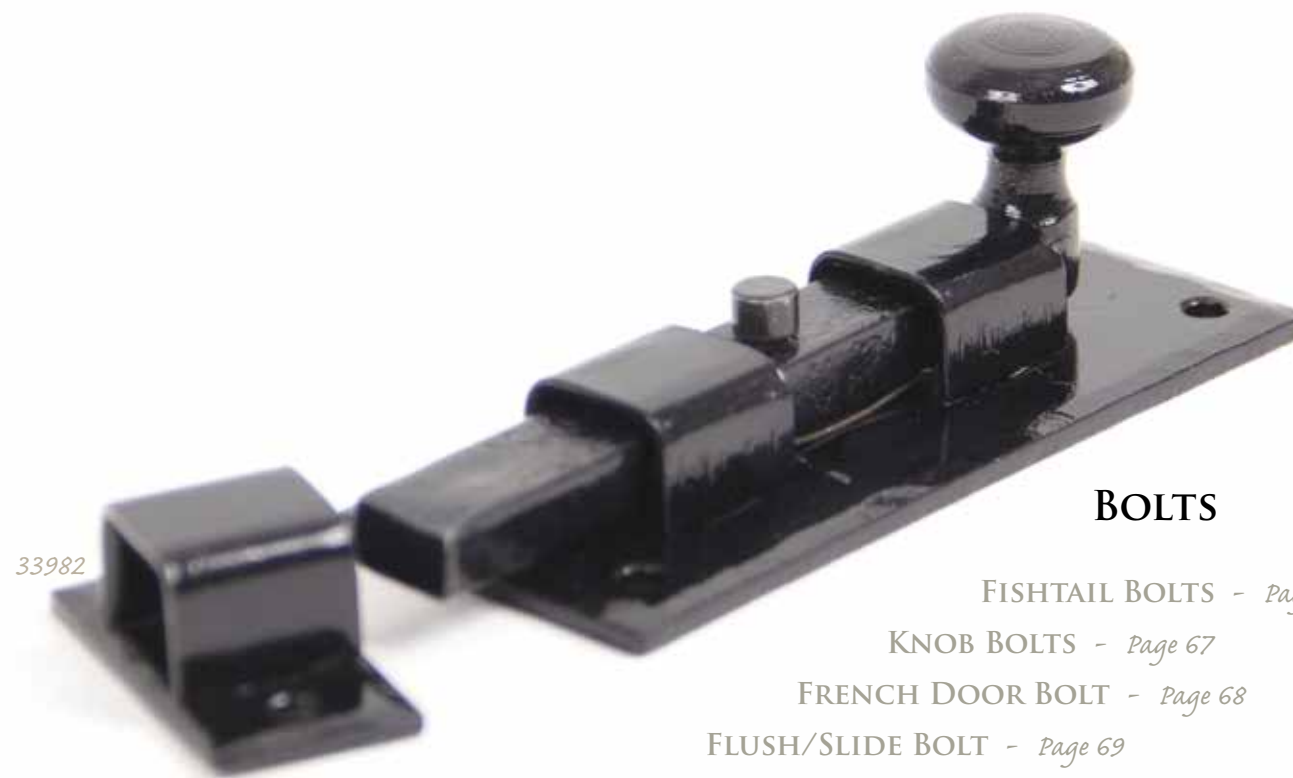

33982

BOLTS

- FISHTAIL BOLTS - Page 66
- KNOB BOLTS - Page 67
- FRENCH DOOR BOLT - Page 68
- FLUSH/SLIDE BOLT - Page 69
- SLIDE BOLT - Page 69

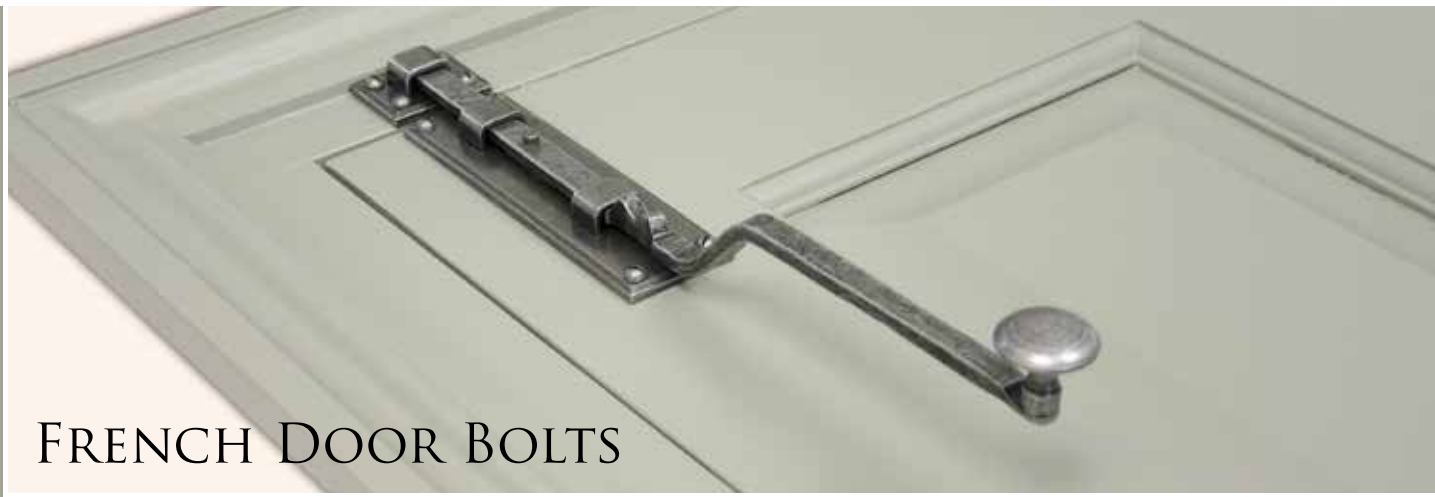

FRENCH DOOR BOLTS

33623 (6" French Door Bolt)

6" FRENCH DOOR BOLT

FIXING PLATE: 153MM X 48MM
RECEIVER BRIDGE: 48MM X 36MM
OVERALL BOLT LENGTH: 380MM

These beautifully crafted bolts have a long cranked handle for ease of use and have a backplate which is 5mm thick. They have a very strong spring for positive action and look elegant on any type of door, painted or natural. Used on inward opening doors but angled keeps are available for outward opening doors (see below).



33855 BEESWAX **33113** BLACK **33623** PEWTER PATINA

ANGLED KEEPS

SIZE: 46MM X 17MM
DEPTH: 15MM

For use with outward opening doors.



33110 BLACK **33711** PEWTER PATINA

10" FRENCH DOOR BOLT

FIXING PLATE: 240MM X 48MM
RECEIVER BRIDGE: 48MM X 36MM
OVERALL BOLT LENGTH: 435MM

These beautifully crafted bolts have a long cranked handle for ease of use and have a backplate which is 5mm thick. They have a very strong spring for positive action and look elegant on any type of door, painted or natural. Used on inward opening doors but angled keeps are available for outward opening doors (see above).

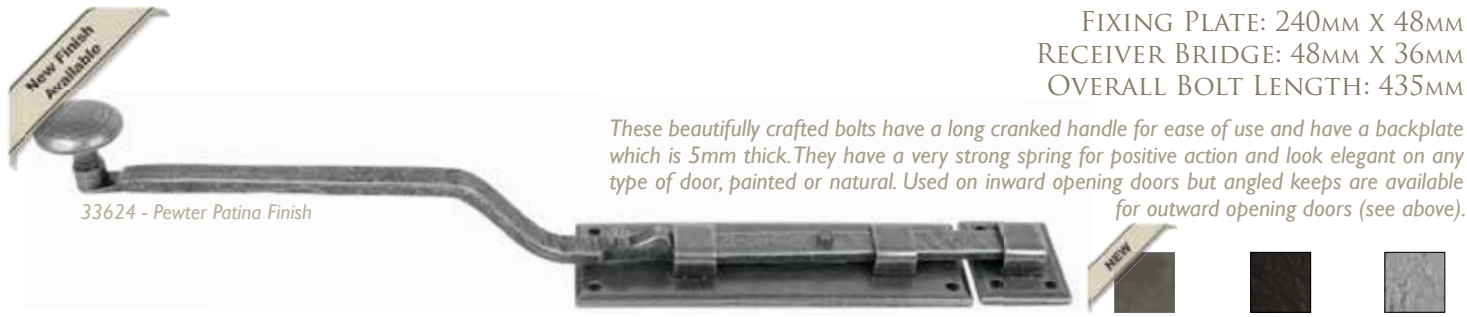

33857 BEESWAX **33114** BLACK **33624** PEWTER PATINA



FLUSH/SLIDE BOLTS

83566 (8" Slide Bolt)

12" FLUSH/SLIDE DOOR BOLT

OVERALL SIZE: 308MM X 20MM
RETURN LENGTH: 32MM
RECEIVER PLATE: 35MM X 20MM
SHOOT BOLT DIAMETER: 9MM

Made from solid steel to give strength and to match our finishes. This flush bolt can be used on sliding/folding door systems. Maximum depth of cut out is 18mm and can be fixed to either the door face or edge.



33627 PEWTER PATINA

6" FLUSH BOLT

OVERALL SIZE: 154MM X 19MM
RETURN LENGTH: 15MM
RECEIVER PLATE: 42MM X 19MM
SHOOT BOLT DIAMETER: 11MM

This product is completely unique to From The Anvil. The faceplate is made from stainless steel to give strength, PVD coated and finished in black. This flush bolt can be used on sliding/folding door systems. Maximum depth of cut out is 25mm and can be fixed to either the door face or edge.



41613 BLACK

8" SLIDE BOLT

BOLT LENGTH: 190MM
FIXING PLATE: 200MM X 44MM
RECEIVER BRIDGE: 54MM X 19MM (PROJECTION: 25MM)
RECEIVER PLATE: 44MM X 25MM

A very solid and chunky looking slide bolt, with a smooth action and a quality Antique Brass finish. Cast from solid brass and comes with a receiver bridge and also a receiver plate to suit both inward and outward opening doors.



83566 ANTIQUE BRASS

HOOKS

- GOTHIC HOOKS - Page 71
- FLEUR-DE-LYS HOOKS - Page 71
- HAT & COAT HOOKS - Page 72
- CUP HOOKS - Page 73
- 'L' HOOKS - Page 73
- CABIN HOOKS - Page 74



83523



33122 (Gothic Hook)

GOTHIC HOOK

OVERALL HEIGHT: 120MM
 PROJECTION: 50MM

This hook is based on Gothic architecture, with its 'pointed arch' styling and has a fine curled over detail at the end of the hook.



33688 - Pewter Patina Finish



33122 BEESWAX **33963** BLACK **33688** PEWTER PATINA

FLEUR-DE-LYS HOOK

OVERALL HEIGHT: 114MM
 PROJECTION: 51MM

The Fleur-de-lys design of this hook lends itself well to fixing a number of them to a piece of reclaimed oak and using in a hallway or kitchen.



33121 - Beeswax Finish



33121 BEESWAX **33834** BLACK **33722** PEWTER PATINA



HAT & COAT HOOKS

83543 (Hat & Coat Hook) & 83523 (Coat Hook)



CUP & 'L' HOOKS

33221 (Cup Hook)

COAT HOOK

FIXING PLATE: 48MM X 38MM
PROJECTION: 70MM

A stylish little coat hook which can be used in a multitude of places like bathrooms, wardrobes and children's rooms etc. Simple yet strong enough to hold a number of items and looks great in any of the four finishes.

83523 - Natural Smooth Finish



83522 - Black Finish

- 
33858
BEESWAX
- 
83522
BLACK
- 
83523
NATURAL SMOOTH
- 
83524
POLISHED BRASS

HAT & COAT HOOK

FIXING PLATE: 44MM X 38MM
OVERALL HEIGHT: 165MM
PROJECTION: 86MM

A simple hat and coat hook with acorn style ends and cast to be very strong and durable. Looks fantastic with four or five hooks fixed to an old piece of oak, natural or painted and hung near a front door or in a porch.



33248 - Beeswax Finish

- 
83542
BLACK
- 
83543
NATURAL SMOOTH
- 
83525
POLISHED BRASS

HAT & COAT HOOK

OVERALL HEIGHT: 197MM
PROJECTION: 108MM

A large number of items can be placed on this product due to its size and strength.

- 
33248
BEESWAX
- 
33249
BLACK



83543 - Natural Smooth Finish

New Finish Available



33220 - Beeswax Finish

CUP HOOK - LARGE

OVERALL SIZE: 89MM X 44MM

This ornate cup hook has a decorative twist in the upright and a nice little curl at the top of the hook. Fixed by way of a drive-in spike.

- 
33220
BEESWAX
- 
33835
BLACK
- 
33800
PEWTER PATINA



33222 - Beeswax Finish

CUP HOOK - SMALL

OVERALL SIZE: 44MM X 25MM

This ornate cup hook has a decorative twist in the upright and a nice little curl at the top of the hook. Fixed by way of a drive-in spike.

- 
33222
BEESWAX
- 
33837
BLACK
- 
33804
PEWTER PATINA



33836 - Black Finish

CUP HOOK - MEDIUM

OVERALL SIZE: 51MM X 32MM

This ornate cup hook has a decorative twist in the upright and a nice little curl at the top of the hook. Fixed by way of a drive-in spike.

- 
33221
BEESWAX
- 
33836
BLACK
- 
33801
PEWTER PATINA

'L' HOOK - LARGE

OVERALL SIZE: 82MM X 32MM

'L' shaped hooks have a decorative curl at the end and can be used in a multitude of ways. Fixed by way of a drive-in spike.

- 
33214
BEESWAX
- 
33214 - Beeswax Finish

'L' HOOK - SMALL

OVERALL SIZE: 70MM X 32MM

'L' shaped hooks have a decorative curl at the end and can be used in a multitude of ways. Fixed by way of a drive-in spike.

- 
33215
BEESWAX
- 
33215 - Beeswax Finish



CABIN HOOKS

83540 (5" Cabin Hook)

8" CABIN HOOK

HOOK LENGTH: 202MM
FIXING PLATES: 41MM X 41MM

Stylish and practical, this cabin hook is made from solid brass and looks elegant on either a painted or natural wood door.



83546 - Polished Brass Finish

83546
POLISHED
BRASS

6" CABIN HOOK

HOOK LENGTH: 154MM
FIXING PLATES: 32MM X 32MM

Stylish and practical, this cabin hook is made from solid brass and looks elegant on either a painted or natural wood door.



83547 - Polished Brass Finish

83547
POLISHED
BRASS

4" CABIN HOOK

HOOK LENGTH: 100MM
FIXING PLATES: 29MM X 29MM

Stylish and practical, this cabin hook is made from solid brass and looks elegant on either a painted or natural wood door.



83548 - Polished Brass Finish

83548
POLISHED
BRASS

3" CABIN HOOK

HOOK LENGTH: 73MM
FIXING PLATES: 29MM X 29MM

Stylish and practical, this cabin hook is made from solid brass and looks elegant on either a painted or natural wood door.



83549 - Polished Brass Finish

83549
POLISHED
BRASS

5" CABIN HOOK

HOOK LENGTH: 127MM
FIXING PLATES: 35MM X 35MM

Stylish and practical, this cabin hook looks elegant in either the Black or the Natural Smooth finish.



83541 - Natural Smooth Finish

83540
BLACK

83541
NATURAL
SMOOTH



CUPBOARD KNOBS, LATCHES & TURNS

BEATEN CUPBOARD KNOBS - Page 76

HAMMERED KNOBS - Page 76

RIBBED KNOB - Page 77

OCTAGONAL KNOBS - Page 77

TWIST KNOB - Page 77

OVAL KNOB - Page 77

CABINET KNOBS & BASE - Page 78

CABINET KNOBS - Page 78

SPIRAL KNOBS - Page 79

CUPBOARD TURN - Page 80

CABINET LATCH - Page 80



BEATEN & HAMMERED CUPBOARD KNOBS

33625 (Beaten Cupboard Knob)

BEATEN CUPBOARD KNOB - LARGE

KNOB SIZE: 40MM
PROJECTION: 31MM

Suitable for hand-crafted cupboard doors. Sold as a single item with M4 screw.



33198 BEESWAX **33993** BLACK **33625** PEWTER PATINA



33625 - Pewter Patina Finish

BEATEN CUPBOARD KNOB - MEDIUM

KNOB SIZE: 30MM
PROJECTION: 25MM

Suitable for hand-crafted cupboard doors. Sold as a single item with M4 screw.



33197 BEESWAX **33992** BLACK **33626** PEWTER PATINA



33992 - Black Finish

BEATEN CUPBOARD KNOB - SMALL

KNOB SIZE: 20MM
PROJECTION: 20MM

Suitable for hand-crafted cupboard doors. Sold as a single item with M4 screw.



33196 BEESWAX **33840** BLACK **33705** PEWTER PATINA



33196 - Beeswax Finish

HAMMERED KNOB - LARGE

KNOB SIZE: 38MM
PROJECTION: 30MM

Suitable for hand-crafted cupboard doors. Sold as a single item with M4 screw. Matches pull handles on page 42.



83515 NATURAL SMOOTH



83515 - Natural Smooth

HAMMERED KNOB - SMALL

KNOB SIZE: 32MM
PROJECTION: 28MM

Suitable for hand-crafted cupboard doors. Sold as a single item with M4 screw. Matches pull handles on page 42.



83516 NATURAL SMOOTH



83516 - Natural Smooth



TWIST, RIBBED, OVAL & OCTAGONAL CUPBOARD KNOBS

33223 (Oval Knob)

RIBBED CABINET KNOB

OVERALL SIZE: 32MM
PROJECTION: 21MM

Suitable for hand-crafted cupboard doors. Sold as a single item with M4 screw. Matches pull handles on page 44.



83536 NATURAL SMOOTH



83536 - Natural Smooth

OCTAGONAL CABINET KNOB - LARGE

OVERALL SIZE: 38MM
PROJECTION: 38MM

Suitable for hand-crafted cupboard doors. Sold as a single item with M4 screw. Matches pull handles on page 43.



83538 NATURAL SMOOTH



83538 - Natural Smooth

OCTAGONAL CABINET KNOB - SMALL

OVERALL SIZE: 32MM
PROJECTION: 38MM

Suitable for hand-crafted cupboard doors. Sold as a single item with M4 screw. Matches pull handles on page 43.



83537 NATURAL SMOOTH



83537 - Natural Smooth

TWIST KNOB

KNOB SIZE: 30MM
PROJECTION: 41MM

Suitable for hand-crafted cupboard doors. Sold as a single item with M4 screw.



33691 PEWTER PATINA



33691 - Pewter Patina Finish

OVAL KNOB

KNOB SIZE: 40MM X 30MM
PROJECTION: 35MM

Suitable for hand-crafted cupboard doors. Sold as a single item with M4 screw.



33223 BEESWAX



33223 - Beeswax Finish

CABINET KNOBS



83550 (Spiral Cabinet Knob)

CABINET KNOB (WITH BASE) - LARGE

OVERALL SIZE: 44MM X 38MM DIA.
 BASE SIZE: 38MM
 PROJECTION: 44MM

A cabinet knob with removable base which looks great on painted cupboards in the kitchen, bathroom or bedroom and compliments the Flower Knob Set by giving the room a uniform look and a stylish feel. Supplied complete with an M4 screw.



83510 - Natural Smooth Finish



83509
BLACK

83510
NATURAL
SMOOTH

CABINET KNOB (WITH BASE) - SMALL

OVERALL SIZE: 41MM X 32MM DIA.
 BASE SIZE: 35MM
 PROJECTION: 41MM

A slightly smaller version of the cabinet knob with a removable base. Compliments our other Natural Smooth and Black finish products and helps to create a stylish look and feel anywhere around the home. Supplied complete with an M4 screw.



83507 - Black Finish



83507
BLACK

83508
NATURAL
SMOOTH

CABINET KNOB - LARGE

OVERALL SIZE: 36MM X 38MM DIA.
 PROJECTION: 36MM

An exceptionally stylish, machined cabinet knob which gives a desirable and contemporary feel. Ideal on larger cupboard doors, kitchen cabinets and a multitude of other areas. A great addition to any room and manufactured to a very high quality. Supplied complete with an M4 screw.



83514 - Natural Smooth Finish



83513
BLACK

83514
NATURAL
SMOOTH

CABINET KNOB - SMALL

OVERALL SIZE: 29MM X 32MM DIA.
 PROJECTION: 29MM

A slightly smaller contemporary, machined cabinet knob which gives a desirable and stylish feel. Ideal on a painted chest of drawers, kitchen cabinets or a multitude of other areas. A great addition to any room and manufactured to a very high quality. Supplied complete with an M4 screw.



83511 - Black Finish



83511
BLACK

83512
NATURAL
SMOOTH

SPIRAL CABINET KNOBS



83550 (Spiral Cabinet Knob)

LARGE SPIRAL CABINET KNOB

DIAMETER: 45MM
 PROJECTION: 66MM

A high quality, large spiral knob ideal for use on cabinets and drawer fronts. Made from solid, heavy brass and supplied complete with an M4 screw.



83552 - Polished Brass Finish



83552
POLISHED
BRASS

MEDIUM SPIRAL CABINET KNOB

DIAMETER: 38MM
 PROJECTION: 58MM

A high quality, medium sized spiral knob ideal for use on cabinets and drawer fronts. Made from solid, heavy brass and supplied complete with an M4 screw.



83551 - Polished Brass Finish



83551
POLISHED
BRASS

SMALL SPIRAL CABINET KNOB

DIAMETER: 32MM
 PROJECTION: 45MM

A high quality, small spiral knob ideal for use on cabinets and drawer fronts. Made from solid, heavy brass and supplied complete with an M4 screw.



83550 - Polished Brass Finish



83550
POLISHED
BRASS

CUPBOARD TURN & CABINET LATCH



33115 (Cupboard Turn)



33684 - Pewter Patina Finish

CUPBOARD TURN

FIXING PLATES: 56MM X 20MM
PROJECTION: 40MM

A stylish, little cupboard turn designed to hold two doors together. Shows all the hand-crafted detail of our skilled blacksmiths.



33115 **33684**
BLACK PEWTER PATINA



83158 - Natural Smooth Finish

CABINET LATCH

OVERALL SIZE: 55MM X 41MM
PROJECTION: 37MM
KEEP SIZE: 55MM X 15MM

A strong and stylish little cabinet latch, ideal for cupboard doors. Comes supplied with fixing screws. Fashioned from cast iron and has a smooth natural iron finish.



83518
NATURAL
SMOOTH



33469

WINDOW FASTENERS & ACCESSORIES

MORTICE PLATE - Page 82

HOOK PLATE - Page 82

PEARDROP FASTENER - Page 82

MONKEYTAIL FASTENERS - Page 83

LOCKING MONKEYTAIL FASTENERS - Page 84

NIGHT VENTING
MONKEYTAIL FASTENERS - Page 84

SHEPHERD'S CROOK FASTENER - Page 85
LOCKING SHEPHERD'S CROOK FASTENER - Page 85

PEARDROP, MONKEYTAIL & SHEPHERD'S CROOK FASTENERS & ACCESSORIES

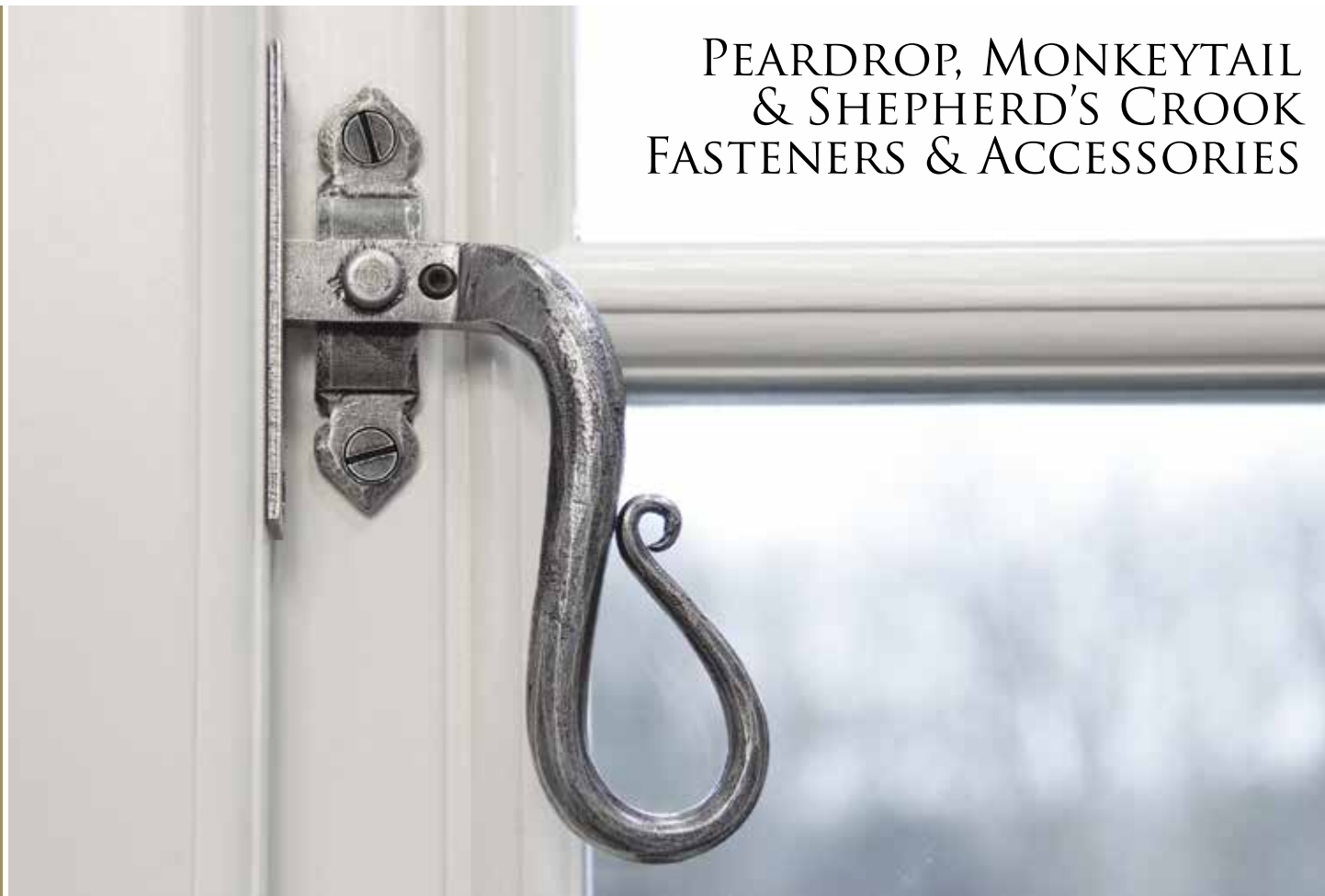

33709 (Shepherd's Crook Locking Fastener - Right Hand)

MONKEYTAIL FASTENER

HANDLE LENGTH: 108MM
FIXING PLATE: 60MM X 19MM
MORTICE PLATE: 76MM X 19MM

This Monkeytail Fastener is reversible so it can be used on either left or right handed windows. Ideal for windows with a draught seal.



33142 BEESWAX **33280** BLACK **33676** PEWTER PATINA



33676 - Pewter Patina Finish

MONKEYTAIL FASTENER

HANDLE LENGTH: 102MM
FIXING PLATE: 55MM X 19MM
MORTICE PLATE: 78MM X 21MM

This solid brass Monkeytail Fastener is reversible and can be used on either left or right handed windows. Ideal for windows with a draught seal.



83593 POLISHED BRASS **83565** ANTIQUE BRASS



83593 - Polished Brass Finish

MORTICE PLATE

OVERALL SIZE: 76MM X 19MM
Sold as a single item with beeswaxed screws.



33140P BEESWAX **33773** PEWTER PATINA



33773 - Pewter Patina Finish

HOOK PLATE

OVERALL SIZE: 57MM X 19MM
For use on windows without a central mullion. Sold as a single item with matching screws.



33237 BEESWAX **33284** BLACK **33669** PEWTER PATINA



33237 - Beeswax Finish

33185 - Beeswax Finish



MONKEYTAIL FASTENER LH

HANDLE SIZE: 114MM X 76MM
FIXING PLATE: 60MM X 13MM
MORTICE PLATE: 76MM X 19MM
HOOK PLATE: 57MM X 19MM

Non-Locking Monkeytail Fasteners are supplied complete with a Hook Plate, which allows fitting to a narrower frame, all fixing screws and a mortice plate.



33185 BEESWAX

PEARDROP FASTENER

HANDLE LENGTH: 127MM
FIXING PLATE: 60MM X 19MM
MORTICE PLATE: 76MM X 19MM

This Peardrop Fastener is reversible so it can be used on either left or right handed windows. Ideal for windows with a draught seal.



33140 BEESWAX **33290** BLACK **33668** PEWTER PATINA **33926** BRONZE



33290 - Black Finish

MONKEYTAIL FASTENER RH

HANDLE SIZE: 114MM X 76MM
FIXING PLATE: 60MM X 13MM
MORTICE PLATE: 76MM X 19MM
HOOK PLATE: 57MM X 19MM

Non-Locking Monkeytail Fasteners are supplied complete with a Hook Plate, which allows fitting to a narrower frame, all fixing screws and a mortice plate.



33186 BEESWAX



33186 - Beeswax Finish

33952 - Black Finish



MONKEYTAIL FASTENER LH - LOCKING

HANDLE SIZE: 114MM X 76MM
 FIXING PLATE: 60MM X 13MM
 MORTICE PLATE: 76MM X 19MM
 HOOK PLATE: 57MM X 19MM

Locking Monkeytail Fasteners are supplied complete with a Hook Plate, which allows fitting to a narrower frame, all fixing screws, a mortice plate and are lockable by way of a grub screw in the handle.



33211 BEESWAX **33952** BLACK **33725** PEWTER PATINA

MONKEYTAIL FASTENER RH - LOCKING

HANDLE SIZE: 114MM X 76MM
 FIXING PLATE: 60MM X 13MM
 MORTICE PLATE: 76MM X 19MM
 HOOK PLATE: 57MM X 19MM

Locking Monkeytail Fasteners are supplied complete with a Hook Plate, which allows fitting to a narrower frame, all fixing screws, a mortice plate and are lockable by way of a grub screw in the handle.



33212 BEESWAX **33953** BLACK **33726** PEWTER PATINA

NIGHT VENT LOCKING MONKEYTAIL FASTENER LH

HANDLE SIZE: 136MM X 44MM
 FIXING PLATE: 60MM X 16MM
 KEEP PLATE: 57MM X 16MM

This product is screw fitted and there is no need for trickle vents. The keep plate will screw to a mullion with a 20mm flat, leaving more room for mouldings. They can be locked in the night-vent and closed positions with an allen key. The nylon washer behind the handle is designed to reduce friction.



33267 BEESWAX **51417L** BLACK **33618** PEWTER PATINA

NIGHT VENT LOCKING MONKEYTAIL FASTENER RH

HANDLE SIZE: 136MM X 44MM
 FIXING PLATE: 60MM X 16MM
 KEEP PLATE: 57MM X 16MM

This product is screw fitted and there is no need for trickle vents. The keep plate will screw to a mullion with a 20mm flat, leaving more room for mouldings. They can be locked in the night-vent and closed positions with an allen key. The nylon washer behind the handle is designed to reduce friction.



33268 BEESWAX **51417R** BLACK **33619** PEWTER PATINA

SHEPHERD'S CROOK FASTENER

HANDLE LENGTH: 101MM
 FIXING PLATE: 59MM X 19MM
 MORTICE PLATE: 76MM X 19MM

This Shepherd's Crook Fastener is reversible so it can be used on either left or right handed windows. Ideal for windows with a draught seal.



33132 BEESWAX **33956** BLACK **33727** PEWTER PATINA



33132 - Beeswax Finish

33476 - Beeswax Finish



SHEPHERD'S CROOK FASTENER LH - LOCKING

HANDLE SIZE: 104MM X 78MM
 FIXING PLATE: 70MM X 17MM
 MORTICE PLATE: 76MM X 19MM
 HOOK PLATE: 70MM X 17MM

A new style of locking window fastener with a beautifully crafted Shepherd's Crook handle. Pack contains both mortice and hook plates for windows of various configurations i.e. with or without central mullion.



33476 BEESWAX **33468** BLACK **33710** PEWTER PATINA

SHEPHERD'S CROOK FASTENER RH - LOCKING

HANDLE SIZE: 104MM X 78MM
 FIXING PLATE: 70MM X 17MM
 MORTICE PLATE: 76MM X 19MM
 HOOK PLATE: 70MM X 17MM

A new style of locking window fastener with a beautifully crafted Shepherd's Crook handle. Pack contains both mortice and hook plates for windows of various configurations i.e. with or without central mullion.



33477 BEESWAX **33469** BLACK **33709** PEWTER PATINA



33709 - Pewter Patina Finish

WINDOW STAYS & ACCESSORIES

PEARDROP STAYS - Page 87

MONKEYTAIL STAYS - Page 88-89

SHEPHERD'S CROOK STAYS - Page 90

CRANKED STAY PIN - Page 87, 88, 89, 90

OFFSET STAY PIN - Page 89



PEARDROP WINDOW STAYS

33149 (12" Peardrop Stay)

12" PEARDROP STAY

OVERALL LENGTH: 330MM
FIXING PLATE: 57MM X 16MM

Our Peardrop Stays are of a very simple design but look very stylish on a painted or natural wood window and with matching fasteners, create that uniform look throughout your home.



- 
33149
BEESWAX
- 
33293
BLACK
- 
33679
PEWTER PATINA
- 
33925
BRONZE
- 
33751
POLISHED BRASS
- 
33754
POLISHED CHROME

10" PEARDROP STAY

OVERALL LENGTH: 267MM
FIXING PLATE: 57MM X 16MM

Our Peardrop Stays are of a very simple design but look very stylish on a painted or natural wood window and with matching fasteners, create that uniform look throughout your home.



- 
33141
BEESWAX
- 
33292
BLACK
- 
33678
PEWTER PATINA
- 
33924
BRONZE
- 
33750
POLISHED BRASS
- 
33753
POLISHED CHROME

8" PEARDROP STAY

OVERALL LENGTH: 228MM
FIXING PLATE: 57MM X 16MM

Our Peardrop Stays are of a very simple design but look very stylish on a painted or natural wood window and with matching fasteners, create that uniform look throughout your home.



- 
33148
BEESWAX
- 
33291
BLACK
- 
33677
PEWTER PATINA
- 
33923
BRONZE
- 
33749
POLISHED BRASS
- 
33752
POLISHED CHROME

CRANKED STAY PIN

FIXING PLATE: 49MM X 12MM
To be used with flush fitting windows or on dummy pvc casements.



- 
33959
BLACK
- 
33614
PEWTER PATINA

33614 - Pewter Patina Finish

HANDMADE MONKEYTAIL WINDOW STAYS



33281 (8" Monkeytail Stay)

12" HANDMADE MONKEYTAIL STAY

OVERALL LENGTH: 317MM
FIXING PLATE: 57MM X 16MM

Our Monkeytail Stays are made from steel so they can be drawn down to a very fine point, reproducing traditional methods. Matching fasteners are available.



33632 - Pewter Patina Finish

-  **33144**
BEESWAX
-  **33283**
BLACK
-  **33632**
PEWTER PATINA

10" HANDMADE MONKEYTAIL STAY

OVERALL LENGTH: 267MM
FIXING PLATE: 57MM X 16MM

Our Monkeytail Stays are made from steel so they can be drawn down to a very fine point, reproducing traditional methods. Matching fasteners are available.



33282 - Black Finish

-  **33143**
BEESWAX
-  **33282**
BLACK
-  **33631**
PEWTER PATINA

8" HANDMADE MONKEYTAIL STAY

OVERALL LENGTH: 228MM
FIXING PLATE: 57MM X 16MM

Our Monkeytail Stays are made from steel so they can be drawn down to a very fine point, reproducing traditional methods. Matching fasteners are available.



33139 - Beeswax Finish

-  **33139**
BEESWAX
-  **33281**
BLACK
-  **33630**
PEWTER PATINA

CRANKED STAY PIN

FIXING PLATE: 49MM X 12MM
To be used with flush fitting windows or on dummy pvc casements.

-  **33959**
BLACK
-  **33614**
PEWTER PATINA



33614 - Pewter Patina Finish

CAST MONKEYTAIL WINDOW STAYS



33453 (10" Monkeytail Stay)

12" MONKEYTAIL STAY

OVERALL LENGTH: 328MM
FIXING PLATE: 45MM X 16MM

This product is made from high quality materials and comes in four unlacquered finishes. Supplied complete with quality, fixing screws.



83569 - Antique Brass Finish

-  **83596**
POLISHED BRASS
-  **83569**
ANTIQUE BRASS
-  **33472**
BLACK
-  **33454**
ANTIQUE PEWTER

OFFSET STAY PIN

FIXING PLATE: 47MM X 12MM
For use on heavily moulded windows.

-  **33457**
POLISHED BRASS
-  **33459**
BLACK
-  **33455**
ANTIQUE PEWTER



33459 - Black Finish

10" MONKEYTAIL STAY

OVERALL LENGTH: 278MM
FIXING PLATE: 45MM X 16MM

This product is made from high quality materials and comes in four unlacquered finishes. Supplied complete with quality, fixing screws.



33453 - Antique Pewter Finish

-  **83595**
POLISHED BRASS
-  **83568**
ANTIQUE BRASS
-  **33471**
BLACK
-  **33453**
ANTIQUE PEWTER

CRANKED STAY PIN

FIXING PLATE: 48MM X 12MM
For flush fitting windows or dummy pvc casements.

-  **33458**
POLISHED BRASS
-  **33460**
BLACK
-  **33456**
ANTIQUE PEWTER



33458 - Polished Brass Finish

8" MONKEYTAIL STAY

OVERALL LENGTH: 228MM
FIXING PLATE: 45MM X 16MM

This product is made from high quality materials and comes in four unlacquered finishes. Supplied complete with quality, fixing screws.



33470 - Black Finish

-  **83594**
POLISHED BRASS
-  **83567**
ANTIQUE BRASS
-  **33470**
BLACK
-  **33452**
ANTIQUE PEWTER

SHEPHERD'S CROOK WINDOW STAYS

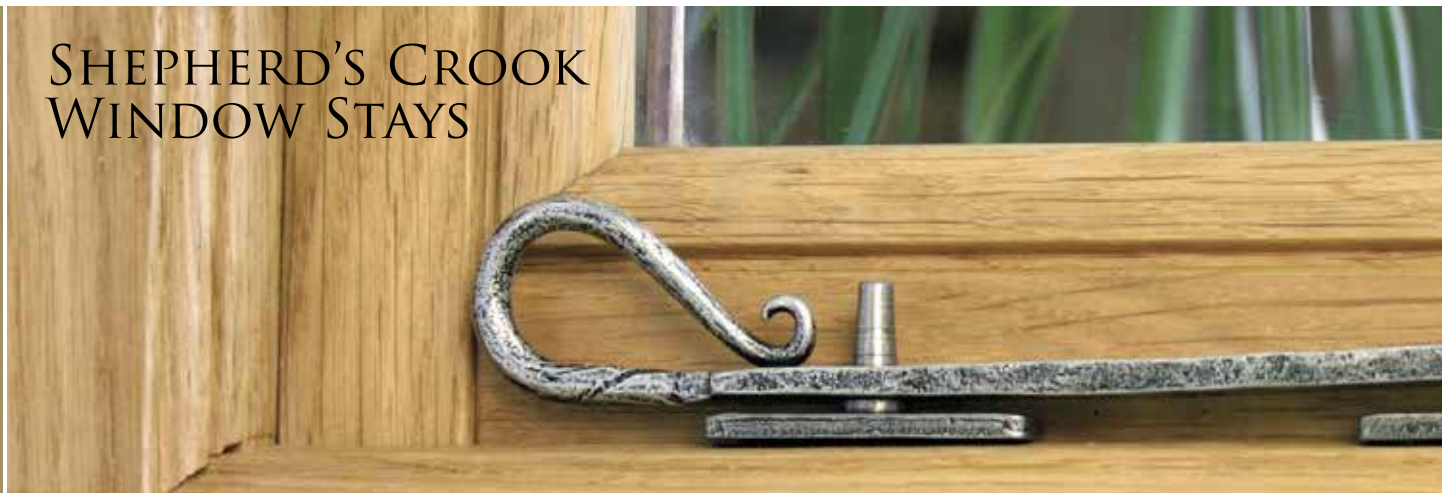

33606 (10" Shepherd's Crook Stay)

12" SHEPHERD'S CROOK STAY

OVERALL SIZE: 356MM
FIXING PLATE: 57MM X 16MM

This Stay has a very delicately, hand-crafted end detail that is unlike any other stay available and can be matched up with our window espagnolettes to create a very unique look.

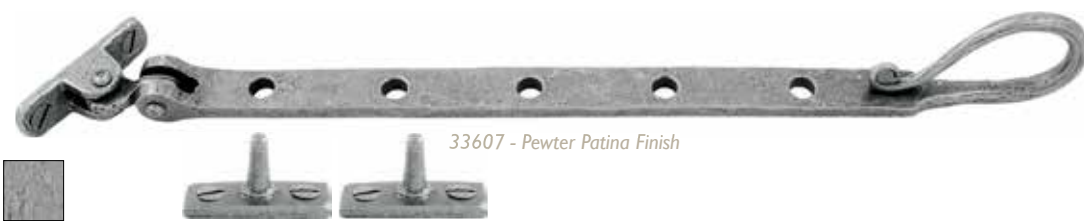

33607 - Pewter Patina Finish

-  **33475**
BEESWAX
-  **33962**
BLACK
-  **33607**
PEWTER PATINA

10" SHEPHERD'S CROOK STAY

OVERALL SIZE: 305MM
FIXING PLATE: 57MM X 16MM

This Stay has a very delicately, hand-crafted end detail that is unlike any other stay available and can be matched up with our window espagnolettes to create a very unique look.



33961 - Black Finish

-  **33474**
BEESWAX
-  **33961**
BLACK
-  **33606**
PEWTER PATINA

CRANKED STAY PIN

FIXING PLATE: 49MM X 12MM
To be used with flush fitting windows or on dummy pvc casements.

-  **33959**
BLACK
-  **33614**
PEWTER PATINA



33614 - Pewter Patina Finish

8" SHEPHERD'S CROOK STAY

OVERALL SIZE: 260MM
FIXING PLATE: 57MM X 16MM

This Stay has a very delicately, hand-crafted end detail that is unlike any other stay available and can be matched up with our window espagnolettes to create a very unique look.

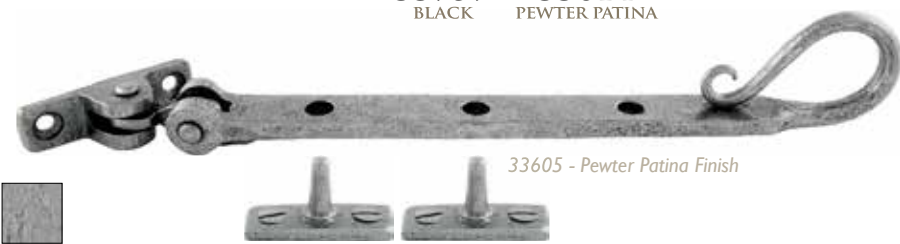

33605 - Pewter Patina Finish

-  **33473**
BEESWAX
-  **33960**
BLACK
-  **33605**
PEWTER PATINA

WINDOW ESPAGNOLETTES

PEARDROP ESPAGNOLETTES - Page 92-93

TEARDROP ESPAGNOLETTES - Page 93

MONKEYTAIL ESPAGNOLETTES - Page 94

SLIM MONKEYTAIL ESPAGNOLETTES - Page 95

DELUXE MONKEYTAIL ESPAGNOLETTES - Page 95

SHEPHERD'S CROOK ESPAGNOLETTES - Page 96



33243



PEARDROP ESPAGNOLETTES

33683 (Peardrop Espagnolette - Right Hand)



PEARDROP ESPAGNOLETTE - LH

OVERALL SIZE: 133MM X 45MM
FIXING PLATE: 64MM X 20MM
FIXING PLATE THICKNESS: 5MM

A very simple yet traditional style of window handle which is ideal for the modern era and looks great on any type of window, including uPVC and timber. Can be fitted to any modern espagnolette rod or stand-alone centre lock (see page 104). Sold complete with a 7mm x 60mm spindle and can be locked with a grub screw hidden under the handle.



33297
BLACK



33682
PEWTER PATINA

PEARDROP ESPAGNOLETTE - RH

OVERALL SIZE: 133MM X 45MM
FIXING PLATE: 64MM X 20MM
FIXING PLATE THICKNESS: 5MM

A very simple yet traditional style of window handle which is ideal for the modern era and looks great on any type of window, including uPVC and timber. Can be fitted to any modern espagnolette rod or stand-alone centre lock (see page 104). Sold complete with a 7mm x 60mm spindle and can be locked with a grub screw hidden under the handle.



33298
BLACK



33683
PEWTER PATINA



33683 - Pewter Patina Finish



20419L - Polished Brass Finish

PEARDROP ESPAGNOLETTE - LH

OVERALL SIZE: 127MM X 60MM
FIXING PLATE: 57MM X 25MM
FIXING PLATE THICKNESS: 6MM

A very simple yet traditional style of window handle which is ideal for the modern era and looks great on any type of window, including uPVC and timber. Can be fitted to any modern espagnolette rod or stand-alone centre lock (see page 104). Sold complete with a 7mm x 50mm spindle and can be locked with a grub screw hidden under the handle.



20419L
POLISHED BRASS



20415L
POLISHED CHROME

PEARDROP ESPAGNOLETTE - RH

OVERALL SIZE: 127MM X 60MM
FIXING PLATE: 57MM X 25MM
FIXING PLATE THICKNESS: 6MM

A very simple yet traditional style of window handle which is ideal for the modern era and looks great on any type of window, including uPVC and timber. Can be fitted to any modern espagnolette rod or stand-alone centre lock (see page 104). Sold complete with a 7mm x 50mm spindle and can be locked with a grub screw hidden under the handle.



20419R
POLISHED BRASS



20415R
POLISHED CHROME



20415R - Polished Chrome

TEARDROP ESPAGNOLETTES



20463 (Brushed Satin Chrome)

TEARDROP ESPAGNOLETTE

OVERALL SIZE: 150MM X 17MM
FIXING PLATE: 55MM X 16MM
FIXING PLATE THICKNESS: 5MM

A unique, traditionally designed Teardrop handle for all types of espagnolette windows. Manufactured from steel-zamak and has the functional advantages of a standard upvc handle with the aesthetics of a traditional design and a unique cranked handle. Comes with a fixed 40mm spindle which allows for cutting. Washered knuckle to allow smooth action and long life. Supplied complete with key and matching fixing screws.



20460
BLACK



20461
POLISHED BRASS



20462
POLISHED CHROME



20463
BRUSHED SATIN CHROME



20460 - Black Finish

20461 - Polished Brass Finish



MONKEYTAIL ESPAGNOLETTES

33288 (Monkeytail Espagnolette - Left Hand)



MONKEYTAIL ESPAGNOLETTE - LH

OVERALL SIZE: 127MM X 38MM
FIXING PLATE: 63MM X 23MM (20MM AVAILABLE)
FIXING PLATE THICKNESS: 5MM



Our Monkeytail Espagnolette handles have been hand-crafted and drawn down to a very fine point by skilled craftsmen and give an exquisite 'curl' detail. Match with the right size Monkeytail Stay to enhance any style of window. Can be fitted to any modern espagnolette rod or stand-alone centre lock (see page 104). Sold complete with a 7mm x 60mm spindle and can be locked with a grub screw hidden under the handle.

- 
33225
BEESWAX
- 
33288
BLACK
- 
33620
PEWTER PATINA

MONKEYTAIL ESPAGNOLETTE - RH

OVERALL SIZE: 127MM X 38MM
FIXING PLATE: 63MM X 23MM (20MM AVAILABLE)
FIXING PLATE THICKNESS: 5MM

Our Monkeytail Espagnolette handles have been hand-crafted and drawn down to a very fine point by skilled craftsmen and give an exquisite 'curl' detail. Match with the right size Monkeytail Stay to enhance any style of window. Can be fitted to any modern espagnolette rod or stand-alone centre lock (see page 104). Sold complete with a 7mm x 60mm spindle and can be locked with a grub screw hidden under the handle.

- 
33224
BEESWAX
- 
33287
BLACK
- 
33621
PEWTER PATINA



33287 - Black Finish



33243 - Black Finish

SLIM MONKEYTAIL ESPAGNOLETTE - LH

OVERALL SIZE: 133MM X 45MM
FIXING PLATE: 64MM X 16MM
FIXING PLATE THICKNESS: 7MM

A narrow style window espag. handle which is ideal for the modern era and fits on any type of window, including uPVC and timber due to its slim fixing plate. Can be fitted to any modern espagnolette rod or stand-alone centre lock (see page 104). Sold complete with a 7mm thick spindle (spindle comes attached with 35mm length showing) and can be locked with a grub screw hidden under the handle.

- 
33243
BLACK
- 
33729
ANTIQU
PEWTER

SLIM MONKEYTAIL ESPAGNOLETTE - RH

OVERALL SIZE: 133MM X 45MM
FIXING PLATE: 64MM X 16MM
FIXING PLATE THICKNESS: 7MM

A narrow style window espag. handle which is ideal for the modern era and fits on any type of window, including uPVC and timber due to its slim fixing plate. Can be fitted to any modern espagnolette rod or stand-alone centre lock (see page 104). Sold complete with a 7mm thick spindle (spindle comes attached with 35mm length showing) and can be locked with a grub screw hidden under the handle.

- 
33242
BLACK
- 
33728
ANTIQU
PEWTER



33728 - Antique Pewter Finish



New Product

20451 - Black Finish

DELUXE MONKEYTAIL ESPAGNOLETTE - LH

OVERALL SIZE: 150MM X 45MM
FIXING PLATE: 55MM X 16MM
FIXING PLATE THICKNESS: 5MM

A unique, traditionally designed Monkeytail handle for all types of espagnolette windows. Manufactured from steel-zamak and has the functional advantages of a standard upvc handle with the aesthetics of a traditional design and a unique cranked handle. Comes with a fixed 40mm spindle which allows for cutting. Washered knuckle to allow smooth action and long life. Supplied complete with key and matching fixing screws.

NEW

- 
20451
BLACK

DELUXE MONKEYTAIL ESPAGNOLETTE - RH

OVERALL SIZE: 150MM X 45MM
FIXING PLATE: 55MM X 16MM
FIXING PLATE THICKNESS: 5MM

A unique, traditionally designed Monkeytail handle for all types of espagnolette windows. Manufactured from steel-zamak and has the functional advantages of a standard upvc handle with the aesthetics of a traditional design and a unique cranked handle. Comes with a fixed 40mm spindle which allows for cutting. Washered knuckle to allow smooth action and long life. Supplied complete with key and matching fixing screws.

NEW

- 
20450
BLACK



20450 - Black Finish



SHEPHERD'S CROOK ESPAGNOLETTES

33603 (Shepherd's Crook Espagnolette - Left Hand)



33958 - Black Finish

SHEPHERD'S CROOK ESPAGNOLETTE - LH

OVERALL SIZE: 127MM X 38MM
 FIXING PLATE: 63MM X 20MM
 FIXING PLATE THICKNESS: 5MM

These Shepherd's Crook Espagnolette handles are hand-crafted to a very fine point and curled over to give fantastic character and detail. It is robust, strong and will last for many years to come. Match up with our Shepherd's Crook Stays to create a completely unique look. Can be fitted to any modern espagnolette rod or stand-alone centre lock (see page 104). Sold complete with a 7mm x 60mm spindle and can be locked with a grub screw hidden under the handle.



33958 **33603**
 BLACK PEWTER PATINA

SHEPHERD'S CROOK ESPAGNOLETTE - RH

OVERALL SIZE: 127MM X 38MM
 FIXING PLATE: 63MM X 20MM
 FIXING PLATE THICKNESS: 5MM

These Shepherd's Crook Espagnolette handles are hand-crafted to a very fine point and curled over to give fantastic character and detail. It is robust, strong and will last for many years to come. Match up with our Shepherd's Crook Stays to create a completely unique look. Can be fitted to any modern espagnolette rod or stand-alone centre lock (see page 104). Sold complete with a 7mm x 60mm spindle and can be locked with a grub screw hidden under the handle.



33957 **33602**
 BLACK PEWTER PATINA



33602 - Pewter Patina Finish

CURTAIN POLE FURNITURE

- LEAF CURTAIN FINIAL - Page 98
- BALL CURTAIN FINIAL - Page 98
- SHELL CURTAIN FINIAL - Page 98
- MOUNTING BRACKET - Page 99
- CURTAIN RINGS - Page 99
- CURTAIN POLES - Page 99
- JOINING BAR FOR CURTAIN POLES - Page 99



83612

TRADITIONAL RANGE CURTAIN FINIALS



83612 (Ball Finial), 83618 (Mounting Bracket), 83619 (Curtain Ring) & 83615 (Curtain Pole)

TRADITIONAL RANGE CURTAIN POLES & ACCESSORIES



83613 (Leaf Finial), 83618 (Mounting Bracket), 83619 (Curtain Ring) & 83615 (Curtain Pole)

LEAF CURTAIN FINIAL

OVERALL SIZE: 200MM X 105MM

A beautifully decorative curtain finial showing every individual hammer blow by our master craftsmen and forged into an ornate curl and shaped into a leaf as an end detail. Always allow enough space for length and height of finial. Sold in pairs.



83613 - Beeswax Finish

83613
BEESWAX

MOUNTING BRACKET

FIXING PLATE: 93MM X 45MM
PROJECTION: 105MM

A decorative mounting bracket specifically designed to be used with our curtain poles. The fixing plate shows every individual hammer blow by our master craftsmen and the strong, sturdy hook can carry any of the curtain poles in our range and has a stylish curled end detail. Sold in pairs.



83618 - Beeswax Finish

83618
BEESWAX

BALL CURTAIN FINIAL

DIAMETER: 42MM
PROJECTION: 45MM

A very simple, solid steel ball shaped finial used to finish off your curtain pole in a simple yet stylish way. Always allow enough space for length of finial. Sold in pairs.



83612 - Beeswax Finish

83612
BEESWAX

CURTAIN RING

DIAMETER: 51MM

A simple curtain ring to match our beeswax range of curtain products. Sold as singles and we suggest using four rings per 300mm.



83619 - Beeswax Finish

83619
BEESWAX

SHELL CURTAIN FINIAL

OVERALL SIZE: 95MM X 45MM

A very original design for a curtain finial, showing every individual hammer blow by our master craftsmen, hand forged and shaped into a leaf as an end detail. Always allow enough space for length of finial. Sold in pairs.



83614 - Beeswax Finish

83614
BEESWAX

CURTAIN POLES

POLE DIAMETER: 22MM
OVERALL SIZE: 1000MM (83615)
OVERALL SIZE: 1500MM (83616)
OVERALL SIZE: 2000MM (83617)

Beeswaxed curtain poles in various lengths. As a rough guide allow a minimum of 300mm extra on the size of your window to allow the curtains to be drawn back. Designed to fit to your wall with our hand forged mounting brackets. Sold as singles.

1M

1.5M

2M

83615
BEESWAX

83616
BEESWAX

83617
BEESWAX

JOINING BAR

SIZE: 100MM X 16MM

A simple bar for joining two lengths of curtain poles together.



83620
ALUMINIUM

LOCKS, LATCHES & ACCESSORIES

- STANDARD LATCHES - Page 101
- STANDARD SASH LOCKS - Page 101
- STANDARD BATHROOM MORTICE LOCKS - Page 101
- HEAVY DUTY LATCHES - Page 102
- HEAVY DUTY SASH LOCKS - Page 102
- HEAVY DUTY BATHROOM MORTICE LOCKS - Page 102
- EURO SASH LOCKS - Page 102
- EURO CYLINDERS & EURO THUMBTURNS - Page 102
- EURO DIN SASH CASE - Page 103
- TUBULAR DEADBOLT - Page 103
- 5 LEVER DEADLOCK BS - Page 103
- 3 POINT DOOR LOCKS - Page 103
- WINDOW LOCKS & KEEP PLATE - Page 104
- SPRING UNIT CASSETTES - Page 104
- TAYLORS SPINDLES - Page 104



2.5" TUBULAR MORTICE LATCH

LATCH SIZE: 64MM
BACKSET: 44MM

A standard tubular mortice latch for use with any of our 'sprung' lever latch handles. As the handles are sprung there is no need to use a heavy duty latch.

Nickel Plated and Black finish plates available.

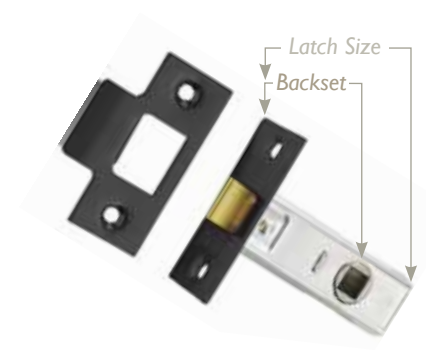

- 
18321N
NICKEL PLATED
- 
18321BL
BLACK



2.5" 5 LEVER SASH LOCK BRITISH STANDARD

LOCK SIZE: 64MM
BACKSET: 44MM

A standard 5 lever sash lock for use with any of our 'sprung' lever lock handles. As the handles are sprung there is no need to use a heavy duty lock.

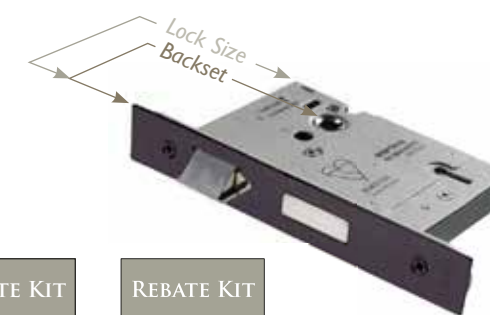
PVD Brass, Satin Stainless Steel and Black finish plates available.



- 
18237
PVD BRASS
- 
18238
SATIN STAINLESS STEEL
- 
18234
BLACK
- 
18237R
PVD BRASS
- 
18239R
SATIN STAINLESS STEEL

2.5" BATHROOM MORTICE LOCK

LOCK SIZE: 64MM
BACKSET: 44MM

For use with any of our bathroom lever handles that come with a fixed thumbturn. As the handles are sprung there is no need to use a heavy duty latch.

Nickel Plated and Black finish plates available.

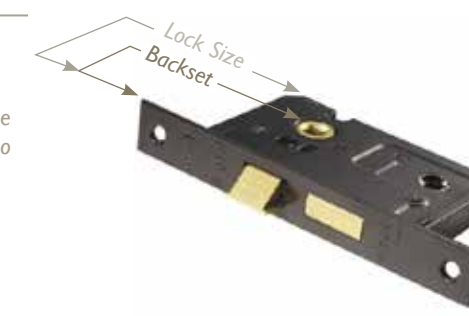

- 
18343N
NICKEL PLATED
- 
18343BL
BLACK

ANVIL 5 LEVER HORIZONTAL SASH LOCK

LOCK SIZE: 151MM
LOCK BACKSET: 57MM
SPINDLE BACKSET: 127MM

A standard 5 lever horizontal sash lock for use with our Monkeytail on Diamond Rosette handle (see page 55 for illustration) and our Mortice Knobs. Supplied with Black Finish forends.

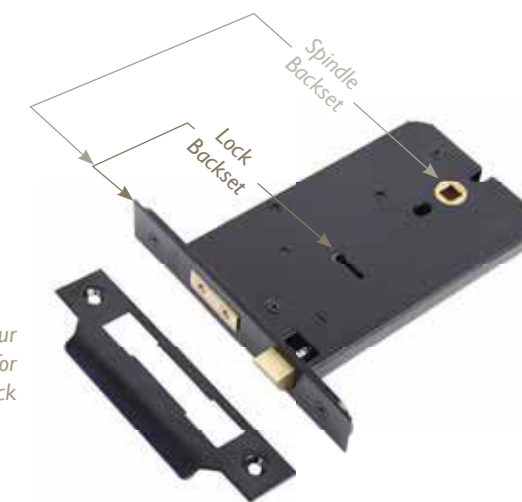

- 
33007
BLACK

HEAVY DUTY LATCH

For use with any of our knob sets or lever latch handles.
 When purchasing knobs we recommend using the 4" or 5" latch (depending on the width of your stile) to avoid knocking your knuckles on the door frame.
 When purchasing lever handles we recommend using the 2.5" or 3" (depending on the width of your stile).

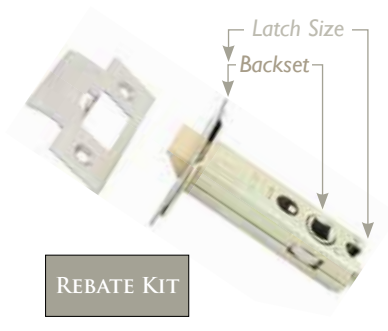

- 2 1/2"
 - 3"
 - 4"
 - 5"
 - REBATE KIT
- 18299/2.5** BACKSET: 44MM **18299/3** BACKSET: 56MM **18299/4** BACKSET: 81MM **18299/5** BACKSET: 106MM **18367**

5 LEVER HEAVY DUTY SASH LOCK BRITISH STANDARD - SSS

For use with any of our knob sets or lever lock handles.
 Choose the 2.5" or 3" lock depending on the width of your stile.

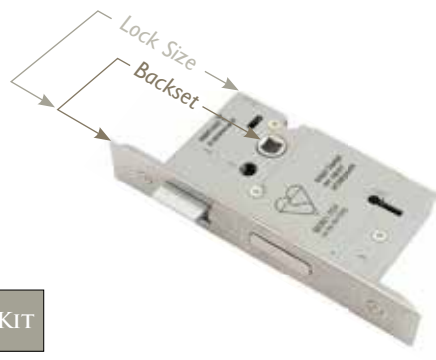

- 2 1/2"
 - 3"
 - REBATE KIT
- 18238/H** BACKSET: 44MM **18239/H** BACKSET: 56MM **18239/R**

HEAVY DUTY BATHROOM MORTICE LOCK - SSS

For use with any of our bathroom lever handles that come with a fixed thumbturn.
 Conforms to British Standards. Choose the 2.5" or 3" lock depending on the width of your stile.

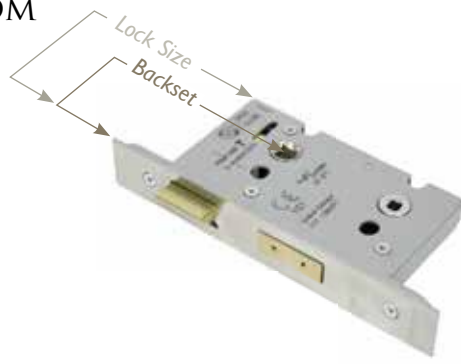

- 2 1/2"
 - 3"
- 18343NHD** BACKSET: 44MM **18338NHD** BACKSET: 56MM

EURO SASH LOCK - SSS

For use with any of our lever euro lock handles and must be used in conjunction with a euro cylinder.
 Choose the 2.5" or 3" lock depending on the width of your stile.

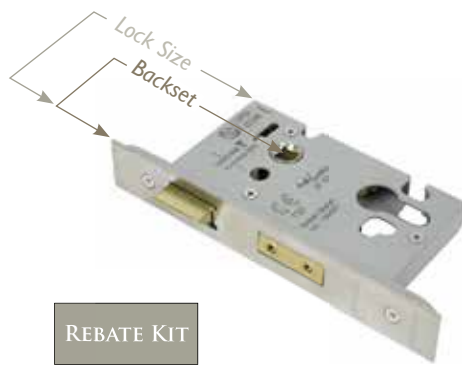

- 2 1/2"
 - 3"
 - REBATE KIT
- 18353** BACKSET: 44MM **18355** BACKSET: 56MM **18357**

EURO CYLINDER

SIZE: 35MM X 35MM
 To be used in conjunction with our Euro Sash Lock and any of the Euro Lever Handles in the Anvil range.



20551
SATIN CHROME

EURO THUMBTURN

SIZE: 35MM X 35MM
 Euro profile thumbturn cylinder offers key access from the outside and a thumbturn from the inside.



20554
SATIN CHROME

EURO DIN SASH CASE - SSS

For use with Diamond Monkeytail and Diamond Euro Escutcheon and must be used in conjunction with a euro cylinder.

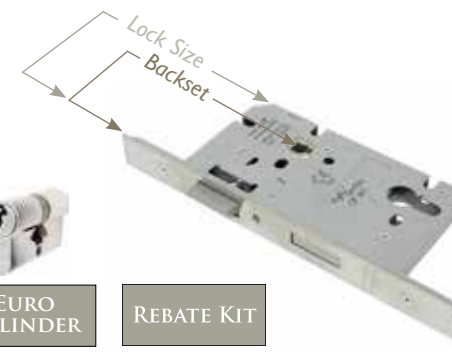

- 2 3/8"
 - EURO CYLINDER
 - REBATE KIT
- 18355/A** BACKSET: 60MM CENTRES: 72MM **20551** SIZE: 35MM X 35MM **18355/R**

HEAVY DUTY TUBULAR DEADBOLT - SSS

For use with our Diamond Bathroom Thumbturn (see page 36). This latch takes a 5mm spindle, which is supplied with the thumbturn.

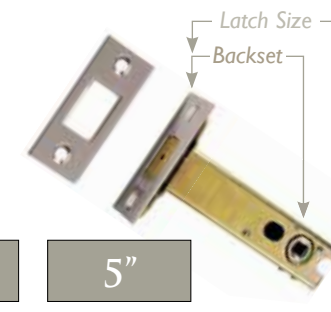

- 2 1/2"
 - 3"
 - 4"
 - 5"
- 18364** BACKSET: 44MM **18361** BACKSET: 56MM **18362** BACKSET: 81MM **18363** BACKSET: 106MM

5 LEVER DEADLOCK BRITISH STANDARD - SSS

Used in addition with our Rim Lock & Cover (33180) to turn into external door lock which complies with British Standards and insurance ratings.
 20mm solid steel anti-thrust, anti-saw, anti-drill bolt throw. Supplied with 3 keys as standard with box striking plate and fixings.

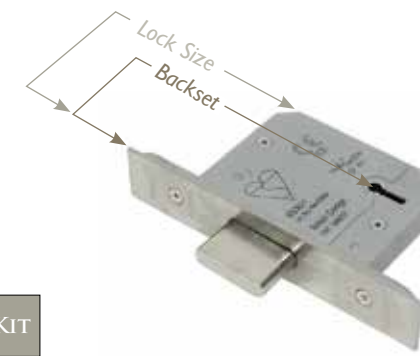

- 2 1/2"
 - 3"
 - REBATE KIT
- 18246/H** BACKSET: 44MM **18243** BACKSET: 56MM **18246/R**

3 POINT DOOR LOCK - SS

For use with our espagnolette locking handle sets. Stainless steel three point espagnolette lock. Excellent quality and a very secure system. Sold in singles. Use 20787 if choosing our Tudor Espag Set to avoid catching the handle on your door frame.

Order keep sets separately:
 20711 - 44mm door
 20709 - 57mm door

- 2"
 - 2 1/2"
- 20786** BACKSET: 35MM **20787** BACKSET: 45MM

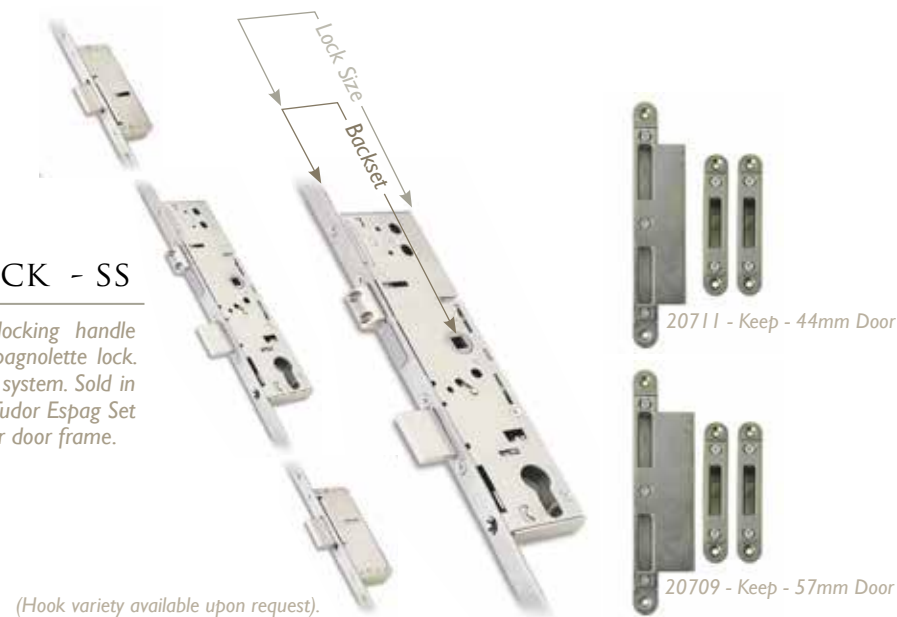

WINDOW LOCK - SS

LOCK SIZE: 30MM
KEEP PLATE SIZE: 90MM X 16MM
FACEPLATE THICKNESS: 2MM

A small, neat window lock with 7mm spindle drive and stainless steel forends. When morticed into edge of window casement it will take any espag. window fastener. The total answer when window has a draft gasket.

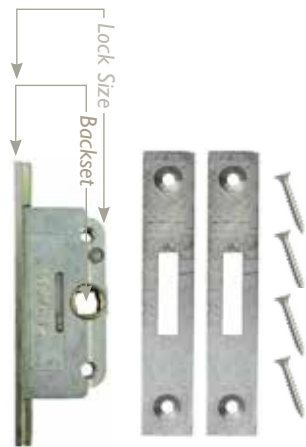

20779
BACKSET: 23MM
(25MM WITH FACEPLATE)

VENTABLE KEEP PLATE - SS

SIZE: 51MM X 24MM

This keep allows a window to be vented and has the added feature of being able to be locked in normal or vented position.



20777

NARROW SPRING UNIT CASSETTE

SIZE: 63MM X 25MM
THICKNESS: 6MM

Will increase performance if your lock is too weak for unsprung handles. Cut into the face of the door so the cassette fits flush with the surface and sits behind your door handle. See our website for more detailed fitting instructions.



33256/A

SPRING UNIT CASSETTE

SIZE: 51MM X 35MM
THICKNESS: 13MM

This cassette is designed to increase the tension and performance of an old or weak lock. Cut into the face of the door so the cassette fits flush with the surface and sits behind your door handle. See our website for more detailed fitting instructions.



33256

THREADED TAYLORS SPINDLE

BASE SIZE: 25MM
SPINDLE: 25MM X 8MM

Can be used to fix threaded knobs to doors and drawers i.e. split set for double wardrobe doors.



31298/A

TAYLORS SPINDLE

BASE SIZE: 25MM
SPINDLE: 25MM X 8MM

Can be used to fix handles to doors i.e. split set for double wardrobe doors.



31298

ELECTRICAL ACCESSORIES

SWITCHES - Page 105

SOCKETS - Page 105

TV OUTLETS - Page 105

SKY+ SOCKETS - Page 105

TELEPHONE SOCKETS - Page 105

SHAVER SOCKETS - Page 105

BLANK PLATES - Page 105

GUIDE TO FINISHES - Page 105



34229/2

We have brought together a number of decorative electrical accessories that we feel are the closest colour and finish match to our handmade ironmongery that is available. See our guide at the bottom of this page to choose what finish best suits your needs.

10 AMP TWO WAY SWITCHES



Single Switch - BN - 34200
Single Switch - SSS - 34200/1
Single Switch - MB - 34200/2

Double Switch - BN - 34201
Double Switch - SSS - 34201/1
Double Switch - MB - 34201/2

Triple Switch - BN - 34202
Triple Switch - SSS - 34202/1
Triple Switch - MB - 34202/2

Quad Switch - BN - 34203
Quad Switch - SSS - 34203/1
Quad Switch - MB - 34203/2

20 AMP SWITCHES



Intermediate Switch (20 Amp)
BN - 34204
SSS - 34204/1
MB - 34204/2

Single 20 Amp DP Switch
BN - 34205
SSS - 34205/1
MB - 34205/2

Single Switch & Neon
BN - 34206
SSS - 34206/1
MB - 34206/2

13 AMP DP SWITCHED SOCKETS



Single Switch Socket
BN - 34223
SSS - 34223/1
MB - 34223/2

Double Switch Socket
BN - 34224
SSS - 34224/1
MB - 34224/2

13 AMP SWITCHED FUSES



Fused Switch & Neon - BN - 34209
Fused Switch & Neon - SSS - 34209/1
Fused Switch & Neon - MB - 34209/2

Fused Switch - BN - 34208
Fused Switch - SSS - 34208/1
Fused Switch - MB - 34208/2

Switched Fuse & Flex - BN - 34210
Switched Fuse & Flex - SSS - 34210/1
Switched Fuse & Flex - MB - 34210/2

Unswitched Fuse - BN - 34207
Unswitched Fuse - SSS - 34207/1
Unswitched Fuse - MB - 34207/2

45 AMP COOKER SWITCHES



45 Amp Single Plate
Cooker Switch

BN - 34212
SSS - 34212/1
MB - 34212/2

45 Amp Double Plate
Cooker Switch

BN - 34211
SSS - 34211/1
MB - 34211/2

45 AMP SWITCH & SOCKET



45 Amp DP Switch
& Socket

BN - 34226
SSS - 34226/1
MB - 34226/2

FAN ISOLATOR SWITCH



Fan Isolator Switch

BN - 34213
SSS - 34213/1
MB - 34213/2

DIMMER SWITCHES



Single - 400w - BN - 34215
Single - 400w - SSS - 34215/1
Single - 400w - MB - 34215/2

Single - 800w - BN - 34216
Single - 800w - SSS - 34216/1
Single - 800w - MB - 34216/2

Double - 400w - BN - 34218
Double - 400w - SSS - 34218/1
Double - 400w - MB - 34218/2

Triple - 400w - BN - 34220
Triple - 400w - SSS - 34220/1
Triple - 400w - MB - 34220/2

Quad - 400w - BN - 34222
Quad - 400w - SSS - 34222/1
Quad - 400w - MB - 34222/2

TV OUTLET



Single TV Socket
BN - 34229
SSS - 34229/1
MB - 34229/2

Double TV Socket
BN - 34230
SSS - 34230/1
MB - 34230/2



All the electrical items on this page
are supplied with black interiors
(switches/rockers) only.

SKY+ SOCKET



BN - 34231
SSS - 34231/1
MB - 34231/2

TELEPHONE SOCKETS



Telephone Slave Socket

BN - 34227
SSS - 34227/1
MB - 34227/2

Telephone Master Socket

BN - 34228
SSS - 34228/1
MB - 34228/2

SHAVER SOCKETS



Dual Volt Shaver Socket

BN - 34232
SSS - 34232/1
MB - 34232/2

BLANK PLATES



Single Blank Plate

BN - 34233
SSS - 34233/1
MB - 34233/2

Double Blank Plate

BN - 34234
SSS - 34234/1
MB - 34234/2

GUIDE TO FINISHES



BLACK NICKEL (BN)
Best suited for Beeswax or
Traditional Black Finishes



SATIN STAINLESS STEEL (SSS)
Best suited for Pewter Finish



MATT BLACK (MB)
Best suited for Black Finish

NEW PRODUCTS

LATCHES - Page 108

LEVER HANDLES - Page 109

DOOR KNOCKERS & CENTRE DOOR KNOBS - Page 110

RIM & MORTICE KNOBS - Page 111

ESCUTCHEONS, CYLINDER PULLS & RIM LOCKS - Page 112

FINGER PLATES - Page 113

TEARDROP & DELUXE MONKEYTAIL ESPAGS. - Page 114



SUFFOLK LATCH

BACKPLATE SIZE: 220MM X 45MM
 HANDLE LENGTH: 100MM
 PROJECTION: 52MM
 PLATE THICKNESS: 4MM

A beautiful latch with lots of stylish features including a long bar with octagonal knob, nicely decorated keeps and a comfortable handle.



73264M
BLACK



73264M - Black Finish

THUMBLATCH SET WITH CHAIN

OVERALL HEIGHT: 200MM
 HANDLE LENGTH: 110MM
 LATCH LENGTH: 150MM

Simple cast Suffolk Latch which can be used on doors up to a thickness of 44mm. Includes a chain on the inside for privacy. Supplied with all fixing screws.



33321
BLACK



33321 - Black Finish

MF LEVER LOCK

BACKPLATE SIZE: 150 X 37MM
 HANDLE LENGTH: 93MM
 CENTRES: 57MM

These attractive, malleable iron handles come sprung. This handle has clean lines with its simple backplate and returned handle. Supplied with all fixing screws.

73205M - Black Finish



73205M
BLACK



LEVER LOCK

BACKPLATE SIZE: 150 X 40MM
 HANDLE LENGTH: 95MM
 CENTRES: 57MM

This traditional, malleable iron handle comes sprung. This handle has a square backplate and a textured finish. Supplied with all fixing screws.



73217M
BLACK



73217M - Black Finish

GOTHIC CURVED ESPAG. LOCK SET

BACKPLATE SIZE: 248MM X 43MM
 BACKPLATE THICKNESS: 5MM
 HANDLE LENGTH: 115MM
 CENTRES: 92MM

The euro version of the Gothic handle is designed to be used in conjunction with a euro sash lock and euro cylinder (see page 102) and allows your door to be locked from inside or outside. Ideal for patio doors or replacement of existing euro handles.



33765 - Pewter Patina Finish



33765
PEWTER PATINA





LOOP DOOR KNOCKER

OVERALL: 180 X 63MM
SCREWS CENTRES: 73MM
STUD: DIA Ø40MM

Solid brass Victorian style Knocker, designed for narrow centre door panels in three finishes. It has a large striking plate and fixed with two hexagon brass nuts.



33610M
POLISHED BRASS

73379M
BLACK

33610
ANTIQUE PEWTER

OVAL MORTICE/RIM KNOB SET

KNOB SIZE: 60MM X 40MM
PROJECTION: 65MM

These attractive and heavy solid oval knobs are designed for use with mortice and rim locks. For use on doors with a max. thickness of 44mm but an extra long spindle is available for thicker doors (see 33230 XLS).

For best results the centre of the knob should be a minimum of 3" from the edge of the door so as not to catch your knuckles against door jambs etc. Heavy Duty latches 4" or 5" are recommended for maximum efficiency. Supplied with matching fixing screws.



83627
POLISHED BRASS

83629
POLISHED NICKEL

CENTRE DOOR KNOB

ROSE SIZE: Ø 85MM
PROJECTION: 80MM

The centre door knob is fitted to the external face of the door. As well as being aesthetically pleasing it is also used to assist in pulling the door closed.



83506
BLACK

83505
ANTIQUE PEWTER



BALL MORTICE KNOB SET

KNOB SIZE: Ø47MM
PROJECTION: 75MM
ROSE SIZE: Ø75MM
SPINDLE SIZE: 8MM

A solid cast Ball Mortice Knob which is unsprung and surfaced fixed. The roses are attached and therefore not suitable for use with Rim Locks.

For best results the centre of the knob should be a minimum of 3" from the edge of the door. Heavy Duty latches 4" or 5" are recommended for maximum efficiency. Supplied with necessary fixing screws.



83630
POLISHED BRASS

83632
POLISHED NICKEL

OVAL EURO ESCUTCHEON

OVERALL SIZE: 51MM X 29MM
THICKNESS: 2.5MM



33830 BLACK **33706** PEWTER PATINA



33830
Black Finish

33706
Pewter Patina Finish

RIM CYLINDER PULL

OVERALL SIZE: 85MM X 52MM
BACKPLATE SIZE: 52MM X 52MM
PROJECTION: 20MM
PLATE THICKNESS: 3MM

Used on front doors to match with black iron door fittings. This cylinder pull should be fitted behind the cylinder of a night latch to assist in pulling the door closed.



73394/1
BLACK



73394/1 - Black Finish

DAVENPORT RIM LOCK

RIM LOCK SIZE: 168MM X 122MM
SPINDLE CENTRE: 125MM
KEY CENTRE: 47MM
KEEP: 116MM X 22MM

A traditional style rim lock which has a very heavy, solid feel to it. Cast from solid iron with quality brass movements inside to produce a weighty, victorian style lock. Comes with two solid brass keys. Allows a maximum door thickness of 45mm.

The lock can be fitted on the left or right hand side of the door. Suitable knobs would be all wooden and beehive pattern or 83564 Brass.



83578
IRON



83578
(Pictured with 83633H)

83578 - Iron Finish



33479 - Beeswax Finish

33466 - Black Finish

PULL HANDLE FINGERPLATE

BACKPLATE SIZE: 318MM X 65MM
HANDLE LENGTH: 200MM
PROJECTION: 56MM
PLATE THICKNESS: 3MM

This heavy duty fingerplate has a large, comfortable handle which is offset and is ideal for single or double doors.

Screw fixing and comes supplied with all necessary fixings



33479 BEESWAX **33466** BLACK



33478 - Beeswax Finish

33467 - Black Finish

PLAIN FINGERPLATE

BACKPLATE SIZE: 318MM X 65MM

This heavy finger plate is fitted to protect the face of a door from wear and tear. It has a strong quality and looks good on oak or painted doors. Ideal for heavy use areas.



33478 BEESWAX **33467** BLACK

GENERAL MAINTENANCE, CARE GUIDE & SPARES

TEARDROP ESPAGNOLETTE

OVERALL SIZE: 150MM X 17MM
FIXING PLATE: 55MM X 16MM
FIXING PLATE THICKNESS: 5MM

A unique, traditionally designed Teardrop handle for all types of espagnolette windows. Manufactured from steel-zamak and has the functional advantages of a standard upvc handle with the aesthetics of a traditional design and a unique cranked handle. Comes with a fixed 40mm spindle which allows for cutting. Washered knuckle to allow smooth action and long life. Supplied complete with key and matching fixing screws.



20460 BLACK
20461 POLISHED BRASS
20462 POLISHED CHROME
20463 BRUSHED SATIN CHROME



DELUXE MONKEYTAIL ESPAGNOLETTE - LH

OVERALL SIZE: 150MM X 45MM
FIXING PLATE: 55MM X 16MM
FIXING PLATE THICKNESS: 5MM

A unique, traditionally designed Monkeytail handle for all types of espagnolette windows. Manufactured from steel-zamak and has the functional advantages of a standard upvc handle with the aesthetics of a traditional design and a unique cranked handle. Comes with a fixed 40mm spindle which allows for cutting. Washered knuckle to allow smooth action and long life. Supplied complete with key and matching fixing screws.



20451
BLACK

DELUXE MONKEYTAIL ESPAGNOLETTE - RH

OVERALL SIZE: 150MM X 45MM
FIXING PLATE: 55MM X 16MM
FIXING PLATE THICKNESS: 5MM

A unique, traditionally designed Monkeytail handle for all types of espagnolette windows. Manufactured from steel-zamak and has the functional advantages of a standard upvc handle with the aesthetics of a traditional design and a unique cranked handle. Comes with a fixed 40mm spindle which allows for cutting. Washered knuckle to allow smooth action and long life. Supplied complete with key and matching fixing screws.



20450
BLACK



General Maintenance

As with any ironmongery on today's market there are general maintenance tips that can be used to keep your products at their best.

Warning: Please make sure all plaster is fully dry before fitting any of our ironmongery. The moisture in a newly plastered room is phenomenal. None of our products are suitable for coastal areas.

With all our products, when used externally, any moving parts will require the occasional oiling and we recommend that the ironmongery is wiped with a lightly oiled cloth from time to time. This will remove harmful deposits and restore it to its original condition. Do not use any form of chemical. Always use the products we recommend for external use, otherwise you may encounter a degradation of the lacquer/wax finish. Our internal finishes aren't recommended for external use but can still be used, if desired, in an enclosed or protected area, like a porch but you may need to reapply an extra coating of wax (beeswax finish only) and you may encounter some rusting issues if not totally protected.



33002
(Maintenance Wax)

When choosing the Beeswax finish, sometimes because of temperature changes, your product might have a slight white bloom when opening the packaging. We recommend you buff it with a soft cloth, this will restore the finish. However, mild steel or malleable iron, which are the two materials we forge, when fitted in damp bathrooms or wet properties, have the potential to exhibit surface rust. If surface rust does occur rub with wire wool and apply maintenance wax with a rag or brush. The maintenance wax will restore the finish and afford protection.

Some of our finishes (Polished & Antique Brass) will naturally tarnish and produce a darker, aged patina over time and would therefore need to be treated with a brass polish to maintain and protect the item, if desired.

Our wooden finishes can also be polished or waxed to maintain the vibrance of the wood and to give protection from general usage.

All of our finishes will last for many years to come but, as with anything, the more you look after something the better it looks!

THREADED SPINDLES

120mm Standard Threaded Spindle	- Spare	- 33230S
140mm Threaded Spindle	- Spare	- 33230XLS
190mm Threaded Spindle	- Spare	- 33230XXLS

MALE & FEMALE SCREWS

5mm Male & Female Screws (2)	- Pewter	- 33767
5mm Male & Female Screws (2)	- Black	- 33768

COUNTERSUNK SCREWS

4 x 1/2" Countersunk Screws (25)	- Beeswax	- 33400
4 x 1/2" Countersunk Screws (25)	- Black	- 33402
4 x 1/2" Countersunk Screws (25)	- Bronze	- 33915
6 x 1/2" Countersunk Screws (25)	- Bronze	- 33920
6 x 3/4" Countersunk Screws (25)	- Beeswax	- 33406
6 x 3/4" Countersunk Screws (25)	- Black	- 33408
6 x 3/4" Countersunk Screws (25)	- Pewter	- 33425
6 x 3/4" Countersunk Screws (25)	- Bronze	- 33919
8 x 3/4" Countersunk Screws (25)	- Beeswax	- 33411
8 x 3/4" Countersunk Screws (25)	- Black	- 33413
8 x 3/4" Countersunk Screws (25)	- Pewter	- 33430
8 x 3/4" Countersunk Screws (25)	- Bronze	- 33937
8 x 1" Countersunk Screws (25)	- Black	- 33417
8 x 1" Countersunk Screws (25)	- Pewter	- 33434

ROUND HEAD SCREWS

4 x 1/2" Round Head Screws (25)	- Beeswax	- 33401
4 x 1/2" Round Head Screws (25)	- Black	- 33403
4 x 1/2" Round Head Screws (25)	- Pewter	- 33421
4 x 1/2" Round Head Screws (25)	- Bronze	- 33913
6 x 1/2" Round Head Screws (25)	- Beeswax	- 33404
6 x 1/2" Round Head Screws (25)	- Pewter	- 33423
6 x 1/2" Round Head Screws (25)	- Bronze	- 33916
6 x 3/4" Round Head Screws (25)	- Beeswax	- 33407
6 x 3/4" Round Head Screws (25)	- Black	- 33409
6 x 3/4" Round Head Screws (25)	- Pewter	- 33426
6 x 3/4" Round Head Screws (25)	- Bronze	- 33917
6 x 1" Round Head Screws (25)	- Black	- 33410
6 x 1" Round Head Screws (25)	- Pewter	- 33427
6 x 1" Round Head Screws (25)	- Bronze	- 33918
8 x 3/4" Round Head Screws (25)	- Beeswax	- 33412
8 x 3/4" Round Head Screws (25)	- Black	- 33414
8 x 3/4" Round Head Screws (25)	- Pewter	- 33431
8 x 3/4" Round Head Screws (25)	- Bronze	- 33939
8 x 1" Round Head Screws (25)	- Beeswax	- 33415
8 x 1" Round Head Screws (25)	- Black	- 33418
8 x 1" Round Head Screws (25)	- Pewter	- 33433
8 x 1" Round Head Screws (25)	- Bronze	- 33938
10 x 1 1/2" Round Head Screws (25)	- Beeswax	- 33419
10 x 1 1/2" Round Head Screws (25)	- Black	- 33420

SUPPLY POLICY

It is our policy to distribute our products through a strong network of trade outlets namely architectural ironmongers and builders' merchants throughout the UK.

CONDITIONS OF SALE

- Slight variations in sizes and colour may occur due to the handcrafted nature of the products. This is why people buy our products because no two items are the same.
- All items shown within this catalogue are offered subject to availability.
- Any prices or quotations obtained verbally will not be deemed valid, nor will any responsibility or intent be accepted.
- Deliveries direct to site will not be undertaken without full postcode, contact name and telephone number. Please note that 'From the Anvil' does not accept any liability for site deliveries and they are sent at the customers' own risk.
- Whilst 'From the Anvil' endeavours to offer outstanding service, our prompt progression of orders means that they maybe unable to include additions with the main consignment once it has been processed and packed. Hence these may be considered as a separate order and be subject to additional carriage charges.
- All requests for returns must be made in writing. The customer will be charged a restocking charge and the goods are to be returned at the customers' own expense. The goods must be in a re-saleable condition and must be authorised by us. If packing is not complete no credit will be given. The customer must provide us with the original invoice, despatch note or other proof of purchase. All goods will be thoroughly inspected before credit is given.
- Claims for shortages, damaged goods or incorrect supply must be notified within 3 days of receipt. No responsibility will be accepted after this interval as the goods will be deemed examined and satisfactory.
- To the best of our knowledge, all definitions, descriptions and photographs contained in this catalogue are correct at the time of going to press. We cannot, however, be held legally liable for any inaccuracies of definition or description.

Please note that any information within this catalogue is to be used as a recommendation of use only, and 'From the Anvil' does not accept any liability. 'From the Anvil' Customers are encouraged to seek other technical advice. Due to the printing process we advise that you do not use the colour images in this catalogue as an indication for colour replication.

- In the event of goods proving faulty by way of manufacture, 'From the Anvil' will replace the same but in doing so, no liability, consequential or otherwise, is accepted.
- 'From the Anvil' warrants that the goods are of merchantable quality (as defined in the Sale of Goods Act 1979) but does not warrant that the goods are fit for any specific purpose and accepts no liability for any loss or damage suffered by the customer as a result of any defect in the design, materials or workmanship of the goods.
- The customer shall indemnify 'From the Anvil' in respect of any loss, injury, expense or claim of whatsoever nature and howsoever arising out of the Contract or the goods, or their storage, installation, use, operation or maintenance save to the extent that the same is caused by negligence of 'From the Anvil', its servants or agents, including 'From the Anvil's subcontractors.

N.B.  is a registered Trademark and may, in no way be reproduced, replicated or copied without prior consent or agreement from the management.



Wherever possible our products have been stamped with an Anvil Authentication Mark to show genuine 'From The Anvil' products.



INDEX

A

Angled Keep
Page 68
Antique
- Brass
Pages 5, 107
- Pewter
Pages 5, 107
Arrow Head T Hinges
Pages 9-11
Art Deco Letterplate
Page 61
Avon Lever Handles
Pages 32-33

B

Ball Bearing Butt Hinge
Page 12
Ball Finial
Page 98
Band & Spike Hinge
Page 10
Bar, Joining
Page 99
Barn Door Hinge
Pages 9-10
Bathroom
- Dead Bolt
Page 103
- Lever Handle
Pages 26-38
- Mortice Lock
Pages 101-102
- Thumbturn
Page 56

Bean

- D Handle
Page 41
- Thumbblatch
Pages 17-18
- Screw-on-staple
Page 20

Beaten Knob

Page 76

Beehive Escutcheon

Page 56

Beeswax Finish

Pages 4, 107

Black Finish

Pages 4, 107

Bolts

- Cranked
Pages 66-67

- Fishtail
Page 66

- Knob
Pages 67, 69

- Flush
Page 69

- French
Page 68

- Slide
Page 69

- Straight
Pages 66-67

Box Lock

Page 51

Bracket, Mounting

Page 99

Brass Finish

- Antique
Pages 5, 107

- Polished
Pages 5, 107

Bronze Finish

Pages 4, 107

Bun Mortice/Rim Knob Set

Page 48

Butt Hinge

Page 12

Butterfly Hinge

Page 14

C

Cabinet & Drawer Furniture

Pages 39-45, 75-80

Cabinet Knobs

Pages 76-79

Cabinet Latch

Page 80

Cabin Hooks

Page 74

Care Guide

Pages 4-5, 107

Cassette, Spring Unit

Page 104

Chrome, Polished

Pages 5, 107

Coat Hook

Page 72

Conditions of Sale

Page 108

Contents

Page 3

Cottage Latch

Page 21

Cottage Lever Handles

Page 29

Cover, Letterplate

Page 60

Cranked

- Bolt
Pages 66-67

- Hinge
Page 9

- Stay Pin
Page 87-90

Cromwell Lever Handles

Page 38

Cupboard

- Beaten Knob
Page 76

- Hammered Knob
Page 76

- Octagonal Knob
Page 77

- Oval Knob
Page 77

- Ribbed Knob
Page 77

- Turn
Page 80

- Twist Knob
Page 77

Cup Hooks

Page 73

Curly Lever Handles

Page 27

Curtain Pole Furniture

- Brackets
Page 99

- Finials
Page 98

- Joining Bar
Page 99

- Poles
Page 99

- Rings
Page 99

Curved Gothic Lever Handles

Page 36

Cylinders

- Euro
Page 102

- Euro Thumbturn
Page 102

D

D Handles

- Bean
Page 41

- Gothic
Page 40

- Hammered
Page 42

- Ribbed
Page 44

- Shell
Page 43

Dead

- Bolt
Page 103

- Lock
Page 103

Diamond

- Escutcheon
Page 55

- Rosette
Page 28

- Thumbturn
Page 56

Door

- Bolts
Pages 65-69

- Furniture
Pages 6-74

- Grill
Page 64

- Knocker
Page 58

- Knobs
Pages 46-49

- Locks
Pages 100-104

- Studs
Page 64

Drawer Pulls

Pages 40-45

Drop Handles

Page 45

E

Ebony Finish

Pages 5, 107

Electrical Accessories

Pages 105-106

Escutcheons

- Beehive
Page 56

- Diamond
Page 55

- Euro
Page 55

- Oval
Page 55

- Oval & Cover
Page 55

- Plain
Page 56

Espagnolette

- Door
Pages 28, 32, 33, 35, 37

- Window
Pages 91-96, 104

Euro

- Escutcheon
Page 55

- Cylinder
Page 102

- DIN Sash Case
Page 103

- Lever Handle
Pages 28, 33, 35

- Sash Lock
Page 102

F

Fasteners

- Monkeytail
Pages 83-84

- Peardrop
Page 82

- Shepherd's Crook
Page 85

Finials, Curtain

Page 98

Finishes Guide

Pages 4-5, 107

Fleur De Lys Hook

Page 71

Flush Bolt

Page 69

Frame Keep Pin

Page 20

French Bolts

Page 68

Fishtail Bolts

Page 66

Flower Mortice Knob Set

Page 49

Furniture

- Cabinet, Cupboard & Drawer
Pages 75-80

- Curtain Pole
Pages 97-99

- Door
Pages 6-74



- Electrical
Pages 105-106
- Window
Pages 81-96

G

General Maintenance

- Page 107
- Gothic
- Curved
Page 36
- D Handle
Page 40
- Hook
Page 71
- Lever Handle
Page 34-35
- Screw-on-staple
Page 20
- Thumbblatch
Page 19
- Grill, Raised
Page 64
- Guides
- Finishes
Page 4-5
- Maintenance & Care
Page 107

H

- H Hinge
Page 13
- Half Butterfly Hinge
Page 14
- Hammered
- Knobs
Page 76
- Pull Handles
Page 42
- Handle
- Cabinet
Page 45
- D
Pages 40-44
- Drop
Page 45
- Lever
Pages 26-38
- Pull
Pages 40-45
- Ring Turn
Page 25
- Handmade Nail
Page 63
- Hat & Coat Hook
Page 72
- Heavy Duty Locks & Latches
Pages 102-103
- Hinge Fronts
Page 12
- Hinges
- Arrow Head Hinge
Pages 9-11
- Ball Bearing Butt Hinge
Page 12
- Band & Spike Hinge
Page 10

- Barn Door Hinges
Pages 9-10
- Butterfly Hinge
Page 14
- Butt Hinge
Page 12
- Fronts
Page 12
- H Hinge
Page 13
- Half Butterfly Hinge
Page 14
- HL Hinge
Page 13
- Hook & Band Hinge
Page 9
- Hook & Band Hinge (Cranked)
Page 9
- Ornate Hinge
Page 15
- Penny End Hinge
Pages 7-8
- Shutter Hinge
Page 15
- Smooth Hinge
Page 11
- T Hinge
Pages 7-11

- HL Hinge
Page 13
- Hook & Band Hinge
Page 9
- Hooks
- Cabin
Page 74
- Coat
Page 72
- Cup
Page 73
- Fleur De Lys
Page 71
- Gothic
Page 71
- Hat & Coat
Page 72
- Hook Plate
Page 82
- L Hook
Page 73
- Horizontal Sash Lock
Page 101

- Iron Finish
Pages 5, 107

J

- Joining Bar
Page 99

K

- Keep
- Angled
Page 68
- Door
Pages 20, 51
- Pin
Page 20

- Ventable Keep Plate
Page 104
- Knobs
- Cabinet & Cupboard
Pages 76-79
- Door
Pages 46-49
- Knob Bolt
Page 101-102
- Locks
- Bathroom Mortice Lock
Page 101-102
- Box
Page 51
- Euro Cylinder
Page 102
- Euro Cylinder Thumbturn
Page 102
- Euro DIN Sash Case
Page 103
- Euro Sash Lock
Page 102
- Heavy Duty Sash Lock
Page 102
- Heavy Duty Tubular Deadbolt
Page 103
- Horizontal Sash Lock
Page 101
- Rim
Pages 50-53
- Sash Lock (Standard)
Page 101
- Window Lock
Page 104
- 3 Point Door Lock
Page 103
- 5 Lever Deadlock BS
Page 103
- 5 Lever Heavy Duty Sash Lock BS
Page 102
- 5 Lever Sash Lock BS
Page 101

L

- L Hooks
Page 73
- Latch
- Cabinet
Page 80
- Cottage
Page 21
- Heavy Duty
Page 102
- Privacy
Page 22
- Set
Page 22
- Shakespeare
Page 23
- 3
Pages 16-20
- Tubular Mortice
Page 101
- Leaf Finial
Page 98
- Letterplates
Pages 59-61
- Letterplate Cover
Page 60
- Lever Handles
- Avon
Pages 32-33
- Cottage
Page 29
- Cromwell
Page 38
- Curly
Page 27
- Gothic
Pages 34-35
- Gothic Curved
Page 36
- Monkeytail
Page 28
- Narrow
Page 32
- Oak
Page 30
- Smooth
Page 30
- Straight
Page 31
- Tudor
Page 37
- Locking Staple Pin
Page 20

Locking Window Fastener

- Pages 84-85
- Locks, Latches & Accessories
- Pages 100-104
- Locks
- Bathroom Mortice Lock
Page 101-102
- Box
Page 51
- Euro Cylinder
Page 102
- Euro Cylinder Thumbturn
Page 102
- Euro DIN Sash Case
Page 103
- Euro Sash Lock
Page 102
- Heavy Duty Sash Lock
Page 102
- Heavy Duty Tubular Deadbolt
Page 103
- Horizontal Sash Lock
Page 101
- Rim
Pages 50-53
- Sash Lock (Standard)
Page 101
- Window Lock
Page 104
- 3 Point Door Lock
Page 103
- 5 Lever Deadlock BS
Page 103
- 5 Lever Heavy Duty Sash Lock BS
Page 102
- 5 Lever Sash Lock BS
Page 101

M

- Maintenance
Pages 5-6, 107
- Maintenance Wax
Page 107
- Monkeytail
- Espagnolette
Pages 94-95
- Fastener
Pages 83-84
- Lever Handles
Page 28
- Stays
Pages 88-89
- Mortice Latch
Pages 101-103
- Mortice Lock
Pages 101-104
- Mortice Plate
Page 82
- Mortice Knob Sets
Page 49
- Mortice/Rim Knob Sets
- Bun
Page 48
- Mushroom
Page 48
- Octagonal
Page 47

- Oval
Page 47
- Ringed
Page 48
- Round
Page 47

Mounting Bracket

- Page 99

N

- Nails
- Handmade
Page 63
- Rosehead
Page 63
- Narrow Lever Handle
Page 32
- Narrow Spring Unit Cassette
Page 104
- Natural Smooth Finish
Pages 5, 107
- Natural Textured Finish
Pages 5, 107
- Night Vent Fastener
Page 84

O

- Oak Box Lock
Page 51
- Oak Lever Handles
Page 30
- Octagonal Mortice/Rim Knob
Page 47
- Octagonal Cabinet Knob
Page 77
- Offset Stay Pin
Page 89
- Ornate Hinge
Page 15
- Oval Escutcheon
Page 55
- Oval Escutcheon & Cover
Page 55
- Oval Knob
Page 77
- Oval Mortice/Rim Knob Set
Page 47

P

- Peardrop
- Espagnolette
Pages 92-93
- Fastener
Page 82
- Stays
Page 87
- Pear Shaped Door Knocker
Page 58
- Penny End
Page 82
- T Hinges
Pages 7-8
- Screw-on-staple
Page 20
- Pewter
- Antique Finish
Pages 5, 107
- Patina Finish
Pages 4, 107

Pin

- Frame Keep
Page 20
- Locking Staple
Page 20
- Staple
Page 20
- Stay
Pages 87-90
- Plain Escutcheon
Page 56
- Plate
- Hook
Page 82
- Mortice
Page 82
- Ventable Keep
Page 104
- Poles, Curtain
Page 99
- Polished
- Brass
Pages 5, 107
- Chrome
Pages 5, 107

- Postal Letterplate
Page 61
- Privacy Latch Set
Page 22
- Product Finishes
Pages 4-5, 107
- Pulls
- Cabinet Handles
Page 45
- D Handles
Pages 40-44
- Drawer
Pages 40-45
- Drop Handles
Page 45
- Pyramidal Door Studs
Page 64

R

- Raised Door Grill
Page 64
- Ribbed
- Cabinet Knob
Page 77
- Pull Handles
Page 44
- Rim Knob Set
Pages 47-48
- Rim Lock
Pages 50-53
- Ring, Curtain
Page 99
- Ring Door Knocker
Page 58
- Ringed Mortice/Rim Knob Set
Page 48
- Ring Turn
- Handle
Page 25
- Shakespeare
Page 25
- Rosehead Nail
Page 63

- Rosewood Finish
Pages 5, 107
- Round Mortice/Rim Knob Set
Page 47

S

- Sash Locks
Pages 101-103
- Screws
Page 107
- Screw-on-staple
- Bean
Page 20
- Gothic
Page 20
- Shakespeare
- Latch
Page 23
- Ring Turn
Page 25
- Shell
- Finials
Page 98
- Pull Handles
Page 43
- Shepherd's Crook
- Fasteners
Page 85
- Espagnolette
Page 96
- Stays
Page 90
- Shutter Hinge
Page 15
- Slide Bolt
Page 69
- Slim Monkeytail
Espagnolette
Page 95
- Slim Thumbblatch
Page 18
- Smooth
- Lever Handle
Page 30
- T Hinge
Page 11
- Sockets, Electrical
Page 106
- Spindle
- Taylors
Page 104
- Threaded, Spare
Page 107
- Spiral Cabinet Knob
Page 79
- Spring Unit Cassette
Page 104
- Staple Pin
Page 20
- Stay Pin
Pages 87-90
- Stay, Window
- Monkeytail
Pages 88-89
- Peardrop
Page 87
- Shepherd's Crook
Page 90

- Stockist, Find A
Page 108
- Straight
- Bolts
Pages 66-69
- Lever Handles
Page 31
- Studs
Page 64
- Supply Policy
Page 108
- Switches, Electrical
Page 106

T

- T Hinges
- Arrow Head
Pages 9-11
- Penny End
Pages 7-8
- Taylors Spindles
Page 104
- Threaded Spindles
Page 107
- Thumbblatch
- Accessories
Page 20
- Bean
Pages 17-18
- Gothic
Page 19
- Slim
Page 18
- Spares
Page 20
- Thumbturn
Page 56
- Tudor Lever Handles
Page 37
- Turns
- Cupboard
Page 80
- Ring
Pages 24-25
- Tubular Deadbolt
Page 103
- Tubular Mortice Latch
Page 101
- Twist Knob
Page 77

- Ventable Keep Plate
Page 104

W

- Window
- Accessories
Pages 82, 87-90
- Espagnolette Handles
Pages 91-96
- Fasteners
Pages 81-85
- Furniture
Pages 81-96
- Locks & Accessories
Page 104
- Stays
Pages 86-90
- Wax, Maintenance
Page 107

FOCUS ON THE ANVIL

Some of our customers entries into the 'Focus on the Anvil Photography Competition' with the winner being voted for by the public and winning £1000!



Owning a period property can be very rewarding but restoration and repair can often be a daunting challenge.

Maintaining that feel of authenticity you originally fell in love with using modern, mass-produced fixtures and fittings is almost impossible.

All our items are hand-forged by master craftsmen using traditional English blacksmithing methods.

The designs are based on timeless classics but hand-forging means no two pieces are identical, each one a unique yet functional work of art that will only enhance it's setting.

We hope you enjoy our new 'From The Anvil' ironmongery collection.

From the
Anvil[®]

NORWICH

61-67 St. Benedicts Street,
Norwich, NR2 4PD
Tel: 01603 216500
Fax: 01603 216510
Email: sales@acleigh.co.uk

COLCHESTER

11 Grange Way,
Whitehall Industrial Estate,
Colchester, CO2 8HG
Tel: 01206 877488
Fax: 01206 877480
Email: colchester@acleigh.co.uk

IPSWICH

Unit 2-3, Dencora Business Centre,
Whitehouse Road, Ipswich, IPI 5LT
Tel: 01473 292810
Fax: 01473 292818
Email: ipswich@acleigh.co.uk

www.acleigh.co.uk