

# ACT

Access Control Technology

---



## **ACT 10 Digital Keypad Operating & Installation Instructions**

## Installation Notes

- Always remember to factory default the controller before you start programming.
- Always remember to place the supplied Varistor across the terminals of the lock terminals to protect the relay contacts.
- Never use the onboard relay to switch AC mains voltage. An external relay isolated electrically from the ACT 10 should be used for this purpose.
- Don't forget to change the programming code to something known only to yourself.

**Important:** As with any Access Control system, always ensure there is an alternate means of escape in the event of the unit failing to operate due to power loss or in the event of fire.

## Product Specification

<b>Number of Users</b>	10 PIN Codes
<b>Supply Voltage</b>	12 – 24 Volts AC or DC
<b>Current Consumption</b>	40mA (nominal), 120mA (maximum)
<b>Operating Temperature</b>	-10 to +50 degrees C
<b>Door Open Time</b>	0 - 255 seconds
<b>Relay Contact Rating</b>	5A / 250Vac
<b>Controller Size (H x W x D):</b>	138 x 87 x 37 (mm)
<b>Controller Weight</b>	700 grams
<b>Installation</b>	Indoor or Outdoor (IP54)
<b>Mounting</b>	Surface or Flush
<b>Output Rating</b>	100mA

## Ordering Information

ACT 10 Digital Keypad	ACT 10
ACT 10 Flush Kit	ACT 10 FK
ACT 10 Weather Shield	ACT 10 WS

## 30 Second Programming Guide

(For typical Standalone System)

### 1. Enter Programming Mode

On the digital keypad press button **x**. Input the programming code (default is 9999). The LED will flash yellow / orange.

### 2. Change User 1 Code

On the digital keypad press button 0, then press 1. Input the new User 1 code (4 digits)


### 3. Change Programming code

On the digital keypad press button 0. Press . Input the new programming code (4 digits)

### 4. Exit Programming Mode

On the digital keypad press button **x**. The LED turns red and programming mode has been exited.

The ACT 10 Digital Keypad is now ready for normal use.

**Note:** The ACT 10 Digital Keypad may be returned to its factory default condition at any time by entering the programming mode and pressing the  button three times.

## For Door 2 Operation

### 1. Enter Programming Mode

### 2. Change User 2 Code

On the digital keypad: Press Button 0, then Press Button 2 (for User 2). Input the new User 2 code (4 digits)

### 3. Assign User 2 to Door 2

On the digital keypad: Press Button 1, then Press Button 2 (for User 2), then Press Button 2 (for Door 2).



### 4. Exit Programming Mode

User 2 code will now activate Door 2 Relay.

## ACT 10 Digital Keypad Programming

Press the **x** button followed by the programming code (initially 9999). The yellow LED will flash while in programming mode. To exit the programming mode press button **x**. Exit from programming mode occurs automatically if no key is activated for 30 seconds.

**Changing Codes:** Enter Programming Mode, then Press

Step	Keypad Entry	Operation	Example: Assign code 7529 to user 7	
1	0	Change Codes	✘9999	Enter programming
2	0-9, 	User Number 0-9,  = programming code	0	Change Codes
3	0000(00)-9999(99)	4 digit code – 0000 deletes User code	7	User 7
			7529	PIN code
			✘	Exit programming

Default User Codes:

Programming Code: 9999(99); User 1 Code: 1234(56). All others are inactive.


**Setting Switched Output Combinations:** Enter Programming Mode, then Press

Step	Keypad Entry	Operation	Example: Assign Toggle to User 7	
1	1	Set Outputs	✘9999	Enter programming
2	0-9	User number 0-9,	1	Set Outputs
3	0-7	Output function code	7	User 7
			0	Door Toggle
			✘	Exit programming

Output Function Code	Door Output	Door 2/Output 2	Output 3
0	Toggled		
1	Timed		
2		Timed	
3	Timed	Timed	
4			Timed
5	Timed		Timed
6		Timed	Timed
7	Timed	Timed	Timed

Default function code is 1 (Relay Timed) for all users. When the door is toggled open, this will be indicated by the green indicator flashing.

**Setting Timers:** Enter Programming Mode, then Press


Step	Keypad Entry	Operation
1	2	Set Timers
2	0 - 4	(Timer number) Buzzer sounds indicating timing. wait required period.
3		(Stop timing) Buzzer stops – timer set.

Timer Number	Function	Default
0	Relay time	5s
1	Door 2 / Output 2 time	5s
2	Output 3 time	5s
3	Door Ajar time	30s
4	Guest Buzzer time	2s

Timers may be set to any duration between 2 seconds and 4 minutes.

**Setting Configuration: Enter Programming Mode, then Press**

Step	Keypad Entry	Operation
1	30-37 or 40-47	option number
2	0 or 1	1= Set, 0 = Unset

Option	Function	Default	Operation
30	Door Chime	Off	When set, whenever the door contact is opened, the built-in buzzer makes a chime sound and the buzzer output activates for 2 seconds.
31	Silent Operation	Off	When set, the keypad operates silently. No audible tones (key-presses or confirm tones) are produced from the built-in buzzer function.
32	Permanent Backlighting	On	When set (default), the keypad illumination is always on. This option will override option 42 (Auto backlighting)
33	Locksaver (Anti Tailgating)	Off	When set, and when the relay is active (following a valid code or button release), the relay timer is truncated to 2 seconds when the door contact opens. This ensures that irrespective of programmed relay time, the door will be locked as soon as it closes, and any person following will have to enter a code.
34	Alarm Keypad Operation	Off	When set, the keypad may be used as a remote keypad for an alarm system. The red and green indicators are controlled by the door contact and the release button inputs respectively, and the built in buzzer is controlled by the interlock input.
35	Interlock	Off	When set, two or more keypads may be interlocked so that only one controlled door may be open at any one time. The interlock output is active whenever the relay is active or when the door contact is open. When the interlock input is active, the release button and all codes are inactive, the red indicator flashes. The interlock outputs and inputs of any number of keypads may be combined on a single wire.
36	Six Digit Codes	Off	When set, all user codes, and the programming code, are six digits long. The default user one code becomes 123456 and the default programmer code becomes 999999.
37	Twin Codes	Off	When set, two different codes must be entered within 15 seconds in order to open the door. The outputs activated are those which have been programmed for the first code to be entered.
40	Door Forced Alarm	Off	When set, the buzzer output is activated, if the door contact opens when a valid code has not been entered. The output is deactivated when a valid code is next entered. This is useful for monitoring fire doors etc.
41	Group Disable	Off	When set, the top five user codes (5-9) are inactive any time the interlock input is activated. This restricts access to certain codes under external control (i.e. an alarm system output or a time clock).
42	Auto backlighting	Off	When set, the keypad illumination is normally off, but will switch on in response to any key being pressed or while in programming mode. This option is overridden by option 32 (permanent backlighting). To prevent any illumination, unset options 32 and 42.
43	Door Ajar Alarm	Off	When set, and the door contact has been open for longer than the time programmed into the door ajar timer, the built-in and external buzzers sound intermittently. The buzzers may be silenced by closing the door and entering a valid code.
44	Guest Button	On	When set (default) and when the  button on the keypad is pressed, the buzzer output is activated for the duration programmed into the guest buzzer timer.
45	Fire Alarm Override	Off	When set, the relay is held active whenever the interlock input is active, and the green indicator will flash. This is useful for allowing a fire alarm system to override controlled doors.
46	Release Button	Off	When set, the interlock input activates the door 2 relay which follows output 2's timer for Second door. This allows two doors to be controlled using one keypad.
47	Duress	Off	When set, and when a duress code is entered, the door is opened normally and output 2 is activated. A duress code is any valid user code with one added to the last digit. The output will be reset when a valid user code is entered. When the duress option is set, user codes which have 9 as the last digit should be avoided as there is no corresponding duress code.

**Incorrect Code Lockout** When three invalid codes have been entered in a row, the keypad will enter lockout mode for 20 seconds. During this time, the red LED indicator will flash and all PIN codes will be inactive.

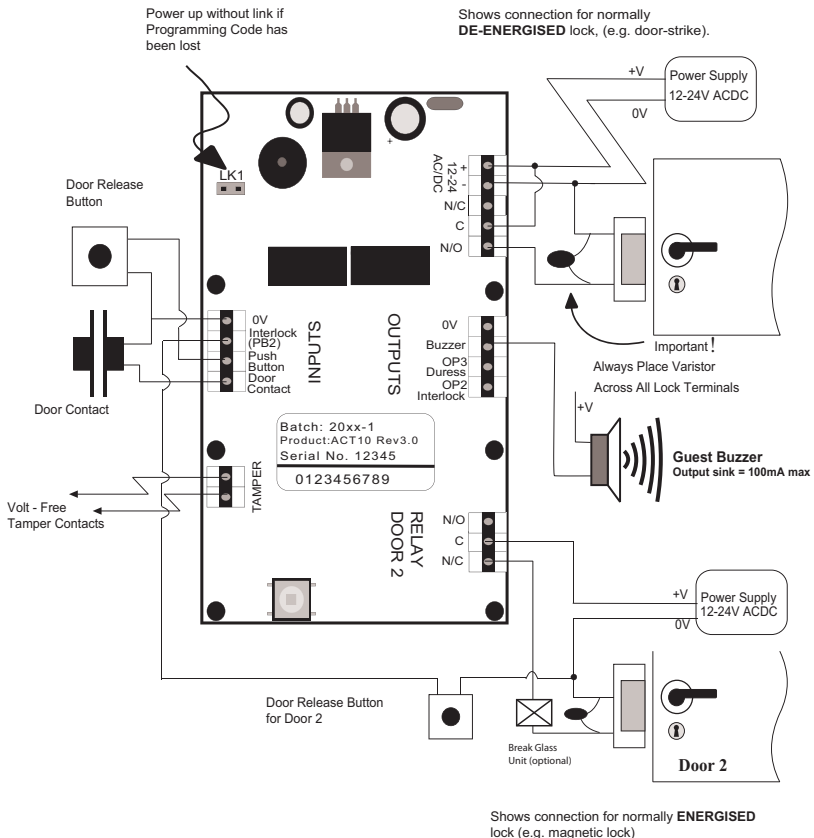
## Restoring Factory Defaults

Enter Programming Mode followed by  $\text{🔔🔔}$ . This restores the ACT 10 Digital Keypad to its default settings. If the Programming Code has been forgotten, it may be set to 9999 by:

1. Remove the power from the unit.
2. Remove link LK1 at the back of the unit.
3. Apply power to unit.
4. Replace link LK1.
5. Proceed with programming.

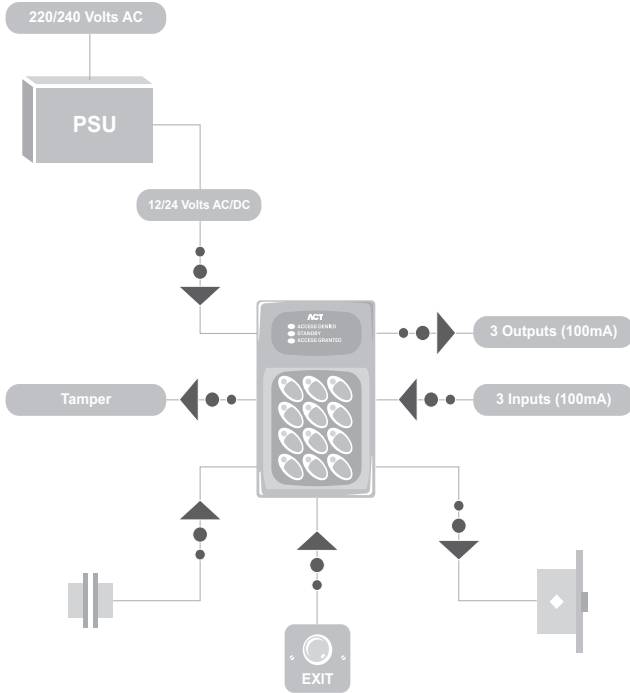
**Note:** The keypad will not operate correctly without LK1 in place.

**Figure 1: Typical ACT 10 Configuration**

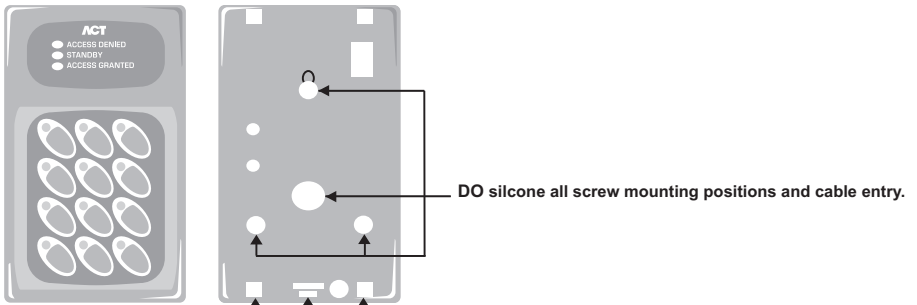


**The ACT 10 may be used to control 2 doors as illustrated in the diagram above**

**Figure 2: ACT 10 Digital Keypad Schematic**

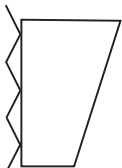


**Figure 3: ACT 10 Digital Keypad - Guide to outdoor installation in exposed areas**



**DO NOT** apply silicone to the bottom of the keypad as this will block the air vents and trap any water which may enter the keypad  
 If a weather shield is fitted the same applies

**DO** apply silicone to the top and two sides of the keypad, or shield, when used.



**DO** install a weather shield when the keypad is  
 1. installed on an uneven surface  
 2. in an exposed area

# Installation Instructions for ACT 10 Flush Mount Kit

- Mount back box into wall void or aperture with wood screws provided
- Ensure that the cable comes through the cable entry in the back box
- Remove back plate from the ACT 10 and mount on to the removable cradle with the 3 bolts provided again bringing the cable through the rear cable entry in the back plate
- Carefully remove the pluggable connector blocks on the ACT 10 and make the required connections
- Replace the wired connectors in their correct positions and install the front housing of the ACT 10 on its back plate. Any excess cable can be shoved back into the void between the cradle and the back box.
- Secure the ACT 10 to its back plate with the security screw.
- Fit the cradle into the back box.
- Fit the front plate to the back box with the 4 security screws provided.

**ACT** Access Control Technology

## User List

User	User Name	PIN	Door 1	Door 2
0				
1				
2				
3				
4				
5				
6				
7				
8				
9				

This manual and user list is available for download from our website, [www.accesscontrol.ie](http://www.accesscontrol.ie)

# ACT

Access Control Technology

Unit C1, South City Business Centre,

Tallaght, Dublin 24, Ireland

Tel: 353-1-4662570 Fax: 353-1-4520427 UK Locall: 0845 300 5204

Web: <http://www.accesscontrol.ie> E-mail: [tech@accesscontrol.ie](mailto:tech@accesscontrol.ie)